

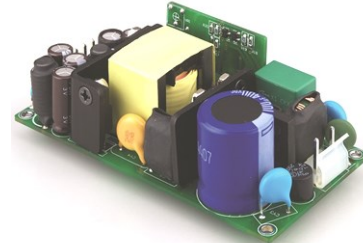

CFM60T SERIES 60W TRIPLE OUTPUT AC-DC MODULES

Features

- Universal Input Range 90~264V_{ac}
- Efficiency to 83%
- 2"x 4" Size
- Meets Class I
- Approval IEC/EN/UL 62368-1
- Approval EN 55032 Class B and CISPR/FCC Class B
- Continuous Short Circuit Protection



MODEL NUMBER	OUTPUT VOLTAGE	OUTPUT CURRENT			VOLTAGE ACCURACY NOTE1	RIPPLE & NOISE NOTE2	LINE REGULATION NOTE3	LOAD REGULATION NOTE4	O/P POWER Max.	%EFF. (Typ.) NOTE5
		Min.	Rated	Max.						
CFM60T-01	5V(V1)	0 A	4.0 A	5.0 A	±2%	50 mV	±1%	±4%	62W	83%
	12V(V2)	0 A	3.0 A	3.7 A	±5%	120 mV	±1%	±3%		
	-12V(V3)	0 A	0.5 A	0.65 A	±5%	120 mV	±1%	±5%		
CFM60T-02	5V(V1)	0 A	4.0 A	5.0 A	±2%	50 mV	±1%	±4%	62W	83%
	15V(V2)	0 A	2.5 A	3.1 A	±4%	150 mV	±1%	±3%		
	-15V(V3)	0 A	0.3 A	0.5 A	±5%	150 mV	±1%	±5%		
CFM60T-03	5V(V1)	0 A	4.0 A	5.0 A	±2%	50 mV	±1%	±4%	62W	83%
	24V(V2)	0 A	1.5 A	1.8 A	±3%	240 mV	±1%	±3%		
	-12V(V3)	0 A	0.5 A	0.6 A	±5%	120 mV	±1%	±5%		
CFM60T-04	3.3V(V1)	0 A	6.0 A	7.5 A	±4%	50 mV	±1%	±5%	40.8W	78%
	5V(V2)	0 A	3.0 A	3.7 A	±5%	50 mV	±1%	±4%		
	-12V(V3)	0 A	0.5 A	0.65 A	±5%	120 mV	±2%	±5%		

Note:

1. Voltage accuracy is set at 60% rated load and 25°C Ta.
2. Add a 0.1uF ceramic capacitor and a 10uF E.L. capacitor to output for ripple & noise measuring @20MHz B.W.
3. Line regulation is measured from 103V_{ac}~127V_{ac} & 207V_{ac}~253V_{ac} with rated load.
4. Load regulation is defined by changing ±40% of measured output load from 60% rated load at other outputs set to 60% rated load.
5. Typical efficiency at 230 V_{ac} and rated load at 25°C.



CFM60T Series

PART NUMBER

Series	Number of Outputs	Nominal Output Voltage	Type
CFM60	T	-XX	-X (Option)
CFM60	T : Triple Output	V1 : 5V 01 : V2 : 12V V3 : -12V	None : Open Frame
		V1 : 5V 02 : V2 : 15V V3 : -15V	
		V1 : 5V 03 : V2 : 24V V3 : -12V	
		V1 : 3.3V 04 : V2 : 5V V3 : -12V	

Part Number Example:

CFM60T-01: Open Frame Type, 60W, Triple Output V1 : 5V, V2 : 12V, V3 : -12V



CFM60T Series

TECHNICAL SPECIFICATIONS

(All specifications are typical at nominal input, 100% full load at 25°C unless otherwise noted.)

ABSOLUTE MAXIMUM RATINGS

PARAMETER	NOTES and CONDITIONS	Device	Min.	Typ.	Max.	Units
Input Voltage	Safety approvals only to the AC input	All	90		264	V_{ac}
			120		370	V_{dc}
Operating Temperature	See Derating Curve	All	0		60	°C
Storage Temperature		All	-20		85	°C
Operating Altitude		All			2000	m

INPUT CHARACTERISTICS

PARAMETER	NOTES and CONDITIONS	Device	Min.	Typ.	Max.	Units
Operating Voltage Range		All	100		240	V_{ac}
Input Frequency Range		All	47		63	Hz
Maximum Input Current	100% full load, $V_{in}=100V_{ac}$	All			1.5	A
Leakage Current		All			3.5	mA
Inrush Current	$V_{in}=240V_{ac}$, Cold start at 25°C	All			50	A

OUTPUT CHARACTERISTICS

PARAMETER	NOTES and CONDITIONS	Device	Min.	Typ.	Max.	Units	
Output Voltage Set Point	V_{in} =Nominal V_{in} , I_o =60% load, T_c =25°C	CFM60T-01	V1	4.9	5.0	5.1	V_{dc}
			V2	11.4	12.0	12.6	
			V3	-12.6	-12.0	-11.4	
		CFM60T-02	V1	4.9	5.0	5.1	
			V2	14.4	15.0	15.6	
			V3	-15.75	-15.0	-14.25	
		CFM60T-03	V1	4.9	5.0	5.1	
			V2	23.28	24.0	24.72	
			V3	-12.6	-12.0	-11.4	
		CFM60T-04	V1	3.17	3.3	3.43	
			V2	4.75	5.0	5.25	
			V3	-12.6	-12.0	-11.4	
Operating Output Current Range	$V_{in}=90V_{ac}\sim 264V_{ac}$, See Derating Curve	CFM60T-01	V1	0	4.0	5.0	A
			V2	0	3.0	3.7	
			V3	0	0.5	0.65	
		CFM60T-02	V1	0	4.0	5.0	
			V2	0	2.5	3.1	
			V3	0	0.3	0.5	
		CFM60T-03	V1	0	4.0	5.0	
			V2	0	1.5	1.8	
			V3	0	0.5	0.6	
		CFM60T-04	V1	0	6.0	7.5	
			V2	0	3.0	3.7	
			V3	0	0.5	0.65	
Holdup Time	$V_{in}=115V_{ac}$	All		8		ms	



CFM60T Series

PARAMETER	NOTES and CONDITIONS	Device	Min.	Typ.	Max.	Units
Output Voltage Regulation						
Load Regulation	Defined by changing $\pm 40\%$ of measured output load from 60% rated load at other output set to 60% rated load.	CFM60T-01	V1		± 4	%
			V2		± 3	
			V3		± 5	
		CFM60T-02	V1		± 4	
			V2		± 3	
			V3		± 5	
		CFM60T-03	V1		± 4	
			V2		± 3	
			V3		± 5	
		CFM60T-04	V1		± 5	
			V2		± 4	
			V3		± 5	
Line Regulation	$V_{in}=103V_{ac}$ to $127V_{ac}$ $V_{in}=207V_{ac}$ to $253V_{ac}$	CFM60T-01	V1		± 1	%
			V2		± 1	
			V3		± 1	
		CFM60T-02	V1		± 1	
			V2		± 1	
			V3		± 1	
		CFM60T-03	V1		± 1	
			V2		± 1	
			V3		± 1	
		CFM60T-04	V1		± 1	
			V2		± 1	
			V3		± 2	
Over Current Protection	Hiccup mode (auto recovery)	All		120	180	%
Short Circuit Protection	Hiccup mode (auto recovery)	All				
Over Voltage Protection	Hiccup mode (auto recovery)	CFM60T-01	V1		7	V_{dc}
			V2		15	
		CFM60T-02	V1		7	
			V2		18	
		CFM60T-03	V1		7	
			V2		28	
		CFM60T-04	V1		6	
			V2		7	
Output Ripple and Noise	1. Add a 0.1 μ F ceramic capacitor and a 10 μ F aluminum electrolytic capacitor to output 2. Oscilloscope is 20MHz bandwidth 3. Ambient temperature= $25^{\circ}C$	CFM60T-01	V1		50	mV
			V2		120	
			V3		120	
		CFM60T-02	V1		50	
			V2		150	
			V3		150	
		CFM60T-03	V1		50	
			V2		240	
			V3		120	
		CFM60T-04	V1		50	
			V2		50	
			V3		120	
Efficiency	1. $V_{in}=230V_{ac}$ 2. Output is 100% full load 3. Ambient temperature= $25^{\circ}C$	CFM60T-01		83	%	
		CFM60T-02		83		
		CFM60T-03		83		
		CFM60T-04		78		



CFM60T Series

ISOLATION CHARACTERISTICS

PARAMETER	NOTES and CONDITIONS	Device	Min.	Typ.	Max.	Units
Input to Output	1 Minute	All			4242	V _{dc}
Isolation Resistance	Input to Output	All	100			MΩ

FEATURE CHARACTERISTICS

PARAMETER	NOTES and CONDITIONS	Device	Min.	Typ.	Max.	Units
Switching Frequency	P _{out} =max. rated power	All		65		kHz

GENERAL SPECIFICATIONS

PARAMETER	NOTES and CONDITIONS	Device	Min.	Typ.	Max.	Units
MTBF	I _o =100%; T _a =25°C per MIL-HDBK-217F I _o =100%; T _a =25°C Telcordia SR332	All	300 2590			k hours
Humidity	Non-condensing	All			93	% RH
Shock	Meet MIL-STD-810F Table 516.5, Table 516.5-I 10ms, each axis 3 times(±X · ±Y · ±Z axis)	All		75		g
Vibration	Meet MIL-STD-810F Table 514.5C-VIII, 15~2000Hz, X · Y · Z axis, 1 hour (each axis),. Total 3 hrs.	All		4		g
Weight		All		160		grams
Dimensions		All	4.000x2.000x1.260 Inches (101.60x50.80x32.00 mm)			
Safety	Class I, IEC/EN/UL 62368-1					Ed.3.0
EMC Emission	EN 55032:2015+A11:2020, Class B EN 61000-3-2:2019, EN 61000-3-3:2013+A1:2019, FCC CFR 47 Part 15					
Conducted Disturbance	EN 55032:2015+A11:2020, FCC CFR 47 Part 15					Class B
Radiated Disturbance	EN 55032:2015+A11:2020, FCC CFR 47 Part 15					Class B
Harmonic Current Emissions	EN 61000-3-2:2019					Class A
Voltage Fluctuations & Flicker	EN 61000-3-3:2013+A1:2019					
EMC Immunity	EN 55035:2017+A11:2020, IEC 61000-4-2, 3, 4, 5, 6, 8, 11					
Electrostatic Discharge (ESD)	IEC 61000-4-2:2008, Air Discharge: ±8kV Contact, Discharge: ±4kV					Criterion A
Radio-Frequency, Continuous Radiated Disturbance	IEC 61000-4-3:2020					Criterion A
Electrical Fast Transient (EFT)	IEC 61000-4-4:2012, ±1kV					Criterion A
Surge	IEC 61000-4-5:2014+A1:2017, L-N: ±0.5kV, ±1kV, L-E(Ground): ±0.5kV, ±1kV, ±2kV					Criterion A
Conducted Disturbances, Induced by RF Fields	IEC 61000-4-6:2013+COR1:2015					Criterion A
Power Frequency Magnetic Field	IEC 61000-4-8:2009					Criterion A
Voltage Dips	IEC 61000-4-11:2020, Dips: 30% Reduction, Dips: >95% Reduction					Criterion A
Voltage Interruptions	IEC 61000-4-11:2020, >95% Reduction					Criterion B
Application Note Link						CFM60T Series App Notes



CHARACTERISTIC CURVE

Power Derating Curve

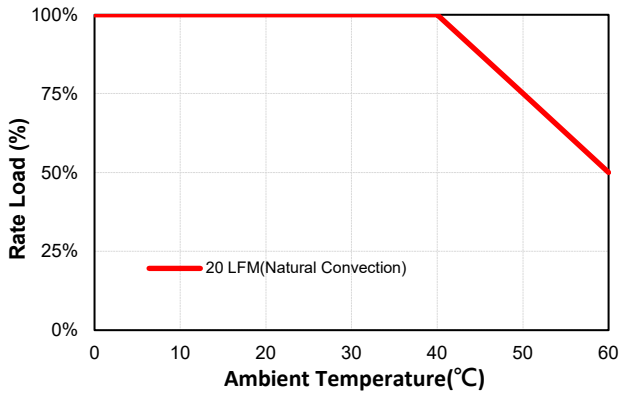

Performance Data

CFM60T-01 (Eff Vs Io)

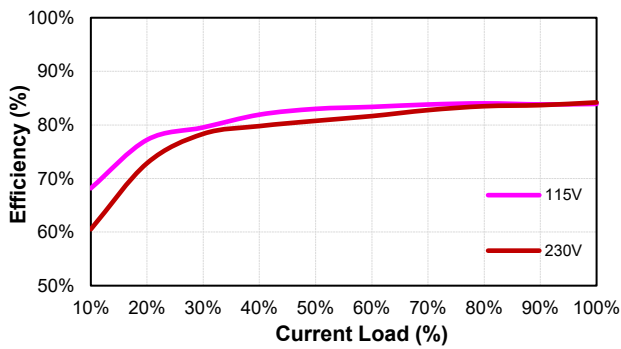

CFM60T-02 (Eff Vs Io)

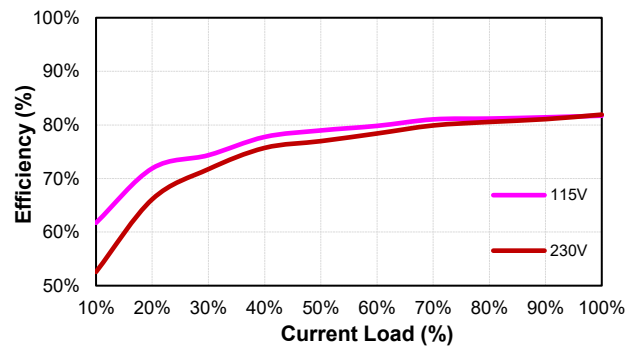

CFM60T-03 (Eff Vs Io)

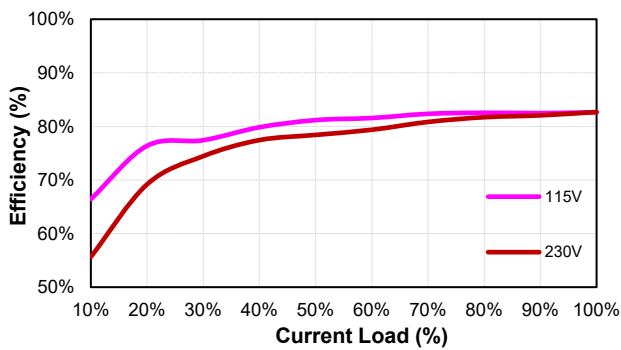

CFM60T-04 (Eff Vs Io)

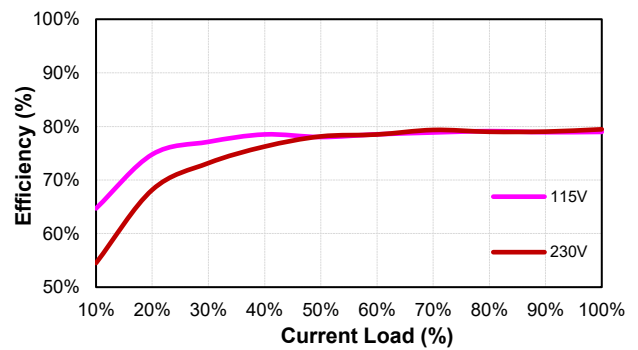



CFM60T Series

MECHANICAL SPECIFICATION

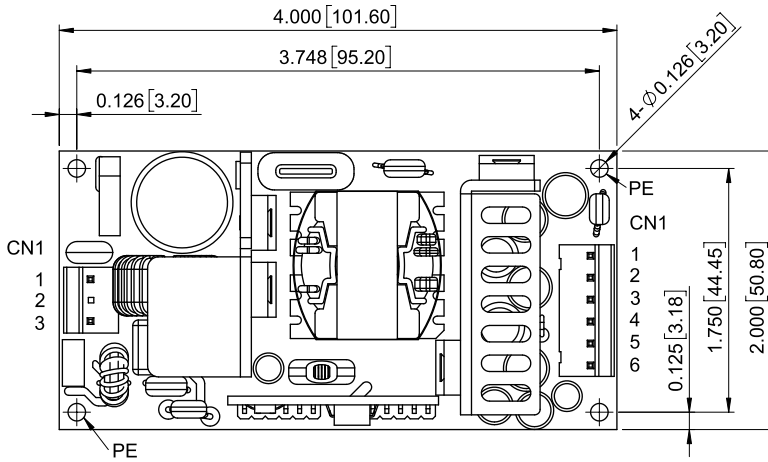

All Dimensions in Inches[mm]
 Tolerance Inches: x.xxx=±0.020
 Millimeters: x.xx=±0.50

AC Input Connector(CN1):LCU P3060-03-2-S2 or equivalent

Pin	Function	Mating Housing	Terminal
1	ACN	MOLEX 09501031 or equivalent	MOLEX 08701031 or equivalent
2	-		
3	ACL		

DC Output Connector(CN2):LCU P3060-06-S2 or equivalent

Pin	Function	Mating Housing	Terminal
1	V2	MOLEX 09501061 or equivalent	MOLEX 08701031 or equivalent
2	V1		
3	V1		
4	GND		
5	GND		
6	V3		

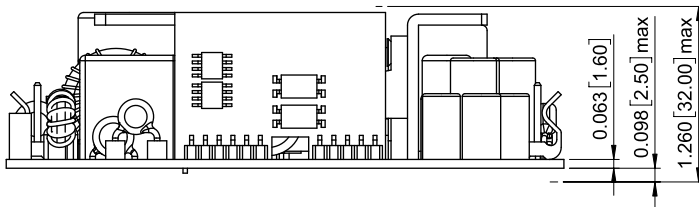

CINCON Electronics Co. Ltd.
 Add: 14F, No. 306, Sec.4, Hsin Yi Rd., Taipei, Taiwan
 Tel: 886-2-27086210
 Fax: 886-2-27029852
 E-mail: sales@cincon.com
 Web: www.cincon.com