



TRE06 SERIES 6 WATT AC-DC I.T.E SWITCHING ADAPTER

Features

- Universal Input Range 90~264Vac
- High Efficiency up to 81%
- Miniature Size
- Optional US&EU AC Plugs
- Class II
- No Load Power Consumption < 75mW
- Approved IEC/UL 62368-1
- Meets EN55032 Class B and CISPR/FCC Class B
- Operating Altitude 4000m
- Continuous Short Circuit Protection
- Constant Current (Optional)
- Meets CoC Tier 2 & DoE Level VI



MODEL NUMBER	OUTPUT VOLTAGE	OUTPUT CURRENT	VOLTAGE ACCURACY NOTE1	RIPPLE & NOISE NOTE2	LINE REGULATION NOTE3	LOAD REGULATION NOTE4	%EFF. (Typ.) NOTE5
TRE06S050	5 V	1200 mA	±4%	100 mV	±1%	±3%	76%
TRE06S090	9 V	650 mA	±3%	100 mV	±1%	±2%	80%
TRE06S120	12 V	500 mA	±3%	120 mV	±1%	±2%	80%
TRE06S150	15 V	400 mA	±3%	120 mV	±1%	±2%	81%

Note:

1. Voltage accuracy is set at 60% full load.
2. Add a 0.1uF ceramic capacitor and a 10uF E.L. capacitor to output for ripple & noise measuring @20MHz BW.
3. Line regulation is measured from 100V_{ac} to 240V_{ac} with 100% full load.
4. Load regulation is measured from 60% to 100% full load and from 60% to 20% full load (60%±40% full load).
5. Typical efficiency at 230 V_{ac} and 75% full load at 25°C.

PART NUMBER

Series	Output Voltage	AC Plug Type	DC Plug Type	Cable Type	Cable Length
TRE06	XXX	-X	-XX	X	XX
6W I.T.E Adapter	050 : 5V 090 : 9V 120 : 12V 150 : 15V	A: USA 2 Pin E: Europe 2 Pin	See Page 5	A : UL2468 without OVP E : UL2468 with OVP	01 : 720mm 02 : 1220mm 03 : 1800mm 11 : 720mm with Ferrite Core 12 : 1220mm with Ferrite Core 13 : 1800mm with Ferrite Core

Part Number Example:

- TRE06S120-A-01A03, 12V_{dc} Output, AC Plug Type, DC Jack Type, without OVP, Cable Length 1800mm
 TRE06S120-E-01E03, 12V_{dc} Output, AC Plug Type, DC Jack Type, with OVP, Cable Length 1800mm



TRE06 Series

TECHNICAL SPECIFICATIONS

(All specifications are typical at nominal input, full load at 25°C unless otherwise noted.)

ABSOLUTE MAXIMUM RATINGS

PARAMETER	NOTES and CONDITIONS	Device	Min.	Typ.	Max.	Units
Input Voltage		All	90		264	V _{ac}
				120		370
Operating Case Temperature	See Derating Curve	All	-20		80	°C
Storage Temperature		All	-20		85	°C
Operating Altitude		All			4000	m

INPUT CHARACTERISTICS

PARAMETER	NOTES and CONDITIONS	Device	Min.	Typ.	Max.	Units
Operating Voltage Range		All	100		240	V _{ac}
Input Frequency Range		All	47		63	Hz
Maximum Input Current	100% Full load, V _{in} =100V _{ac}	All			0.25	A
Leakage Current		All			250	uA
Inrush Current	V _{in} =240V _{ac} , Cold start at 25°C	All			90	A

OUTPUT CHARACTERISTICS

PARAMETER	NOTES and CONDITIONS	Device	Min.	Typ.	Max.	Units
Output Voltage Set Point	V _{in} =115V _{ac} and 230V _{ac} , I _o =60% Full load T _c =25°C	TRE06S050	4.8	5	5.2	V _{dc}
		TRE06S090	8.73	9	9.27	
		TRE06S120	11.64	12	12.36	
		TRE06S150	14.55	15	15.45	
Operating Output Current Range	V _{in} =115V _{ac} and 230V _{ac} , T _c =25°C	TRE06S050			1.2	A
		TRE06S090			0.65	
		TRE06S120			0.5	
		TRE06S150			0.4	
Holdup Time	V _{in} =115V _{ac}	All		10		ms
Output Voltage Regulation						
Load Regulation	60%±40% Full load change	TRE06S050			±3.0	%
		TRE06S090			±2.0	
		TRE06S120			±2.0	
		TRE06S150			±2.0	
Line Regulation	V _{in} =100V _{ac} to 240V _{ac}	All			±1.0	%
Over Current Protection	Auto recovery	All	110		160	%
Short Circuit Protection	Auto recovery	All				
Output Ripple and Noise	1. Add a 0.1uF ceramic capacitor and a 10uF aluminum electrolytic capacitor to output 2. Oscilloscope is 20MHz band width 3. Ambient temperature=25°C	TRE06S050			100	mV
		TRE06S090			100	
		TRE06S120			120	
		TRE06S150			120	
Load Capacitance	1. V _{in} =115V _{ac} and 230V _{ac} 2. Output is max. load 3. Ambient temperature=25°C	TRE06S050			1200	uF
		TRE06S090			680	
		TRE06S120			560	
		TRE06S150			400	
Efficiency	1. V _{in} =230V _{ac} 2. Output is 75% full load 3. Ambient temperature=25°C	TRE06S050		76		%
		TRE06S090		80		
		TRE06S120		80		
		TRE06S150		81		



TRE06 Series

ISOLATION CHARACTERISTICS

PARAMETER	NOTES and CONDITIONS	Device	Min.	Typ.	Max.	Units
Input to Output	1 minute	All			3000	V _{ac}
Isolation Resistance	Input to output	All	100			MΩ

FEATURE CHARACTERISTICS

PARAMETER	NOTES and CONDITIONS	Device	Min.	Typ.	Max.	Units
Switching Frequency	Pout=max. rated power	All		30~70		kHz

GENERAL SPECIFICATIONS

PARAMETER	NOTES and CONDITIONS	Device	Min.	Typ.	Max.	Units
MTBF	I _o =100%; T _a =25°C per MIL-HDBK-217F	All	900			k hours
Humidity	Non-condensing	All			93	% RH
Shock	Meet MIL-STD-810F Table 516.5, Table 516.5-1 10ms, each axis 3 times(±X · ±Y · ±Z axis)	All		75		g
Vibration	Meet MIL-STD-810F Table 514.5C-VIII, 15~2000Hz, X · Y · Z axis, 1 hour (each axis),.. Total 3 hrs.	All		4		g
Weight		All		55		g
Dimensions		All	2.047x1.417x0.992 inches (52.00x36.00x25.21 mm)			
Safety	Class II, IEC/UL 62368-1/60950-1					Ed.2.0
EMC Emission	EN 55032:2012+AC:2013, EN 61000-3-3:2013, FCC 47 CFR Part 15 Class B					
Conducted Disturbance	EN 55032:2012+AC:2013, FCC 47 CFR Part 15 Class B					Class B
Radiated Disturbance	EN 55032:2012+AC:2013, FCC 47 CFR Part 15 Class B					Class B
Voltage Fluctuations	EN 61000-3-3:2013					
EMC Immunity	EN 55024:2010+A1:2015, EN 61204-3: 2000, EN 61000-4-2, 3, 4, 5, 6, 8, 11					
Electrostatic Discharge (ESD)	EN 61000-4-2:2009, Air Discharge: ±8kV Contact Discharge: ±4kV					Criteria B
Radio-Frequency, Continuous Radiated Disturbance	EN 61000-4-3:2006+A1:2008+A2:2010					Criteria A
Electrical Fast Transient (EFT)	EN 61000-4-4:2012, ±0.5kV, ±1kV					Criteria B
Surge	EN 61000-4-5:2014, L-N: ±1kV					Criteria B
Conducted disturbances, induced by RF fields	EN 61000-4-6:2014					Criteria A
Power frequency magnetic field	EN 61000-4-8:2010					Criteria A
Voltage dips	EN 61000-4-11:2004, 100% reduction					Criteria A
	EN 61000-4-11:2004, 30% reduction					Criteria B
Voltage interruptions	EN 61000-4-11:2004, 100% reduction					Criteria B
Application Note Link	TRE06 Series App Notes					



CHARACTERISTIC CURVE

Power Derating Curve

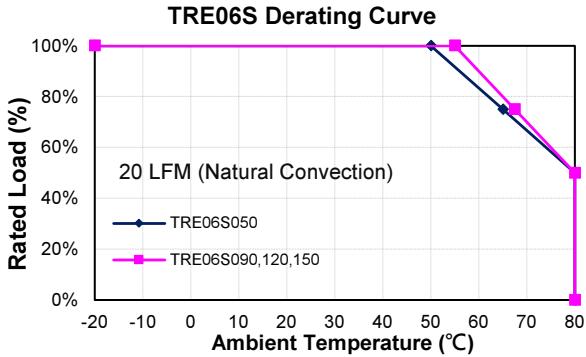

Performance Data

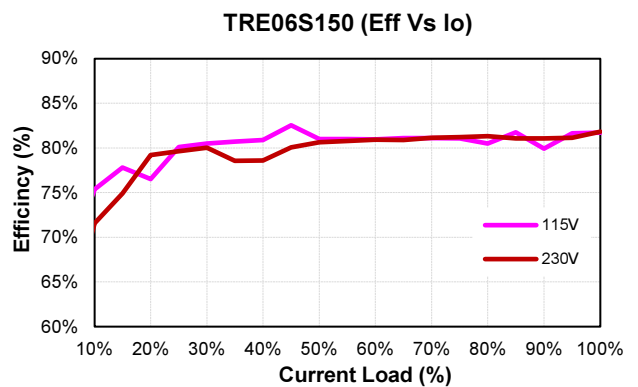
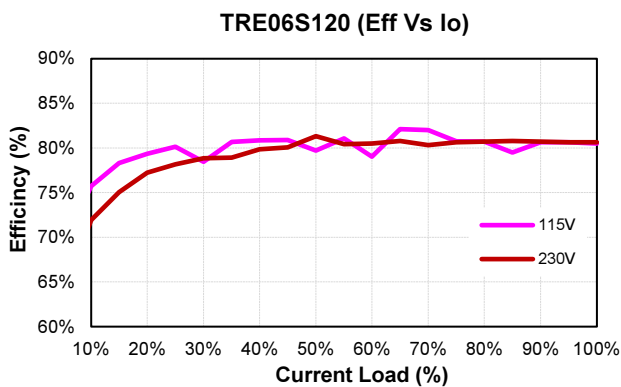
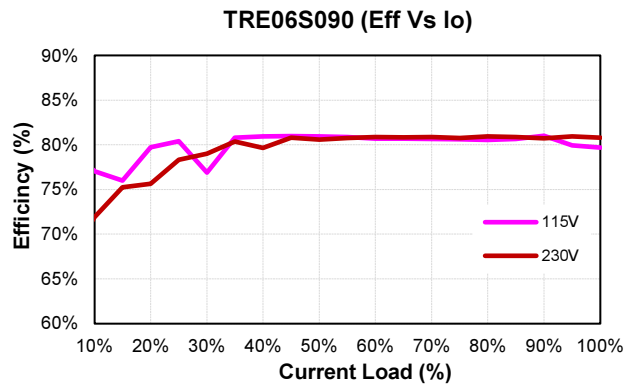
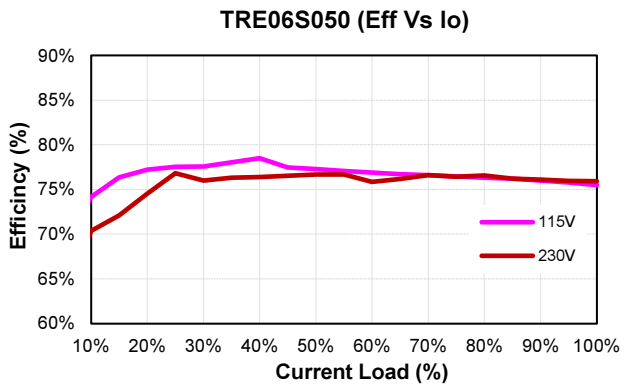

MECHANICAL SPECIFICATION

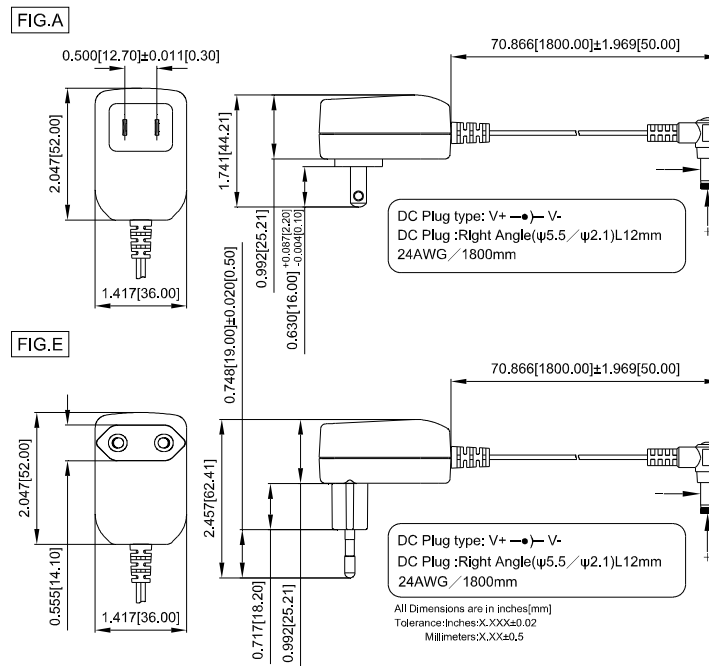

STANDARD OUTPUT PLUG

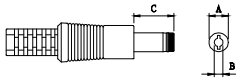
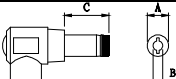
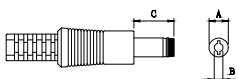
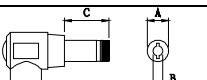
DC Plug Type	Cable Number -XXXXX	A	B	C	Cable Type	Cable Length	Cable AWG
		OD (mm)	ID (mm)	L (mm)			
 Straight/Inner+Outer- + ●) -	11A03	Φ5.5	Φ2.1	12	UL2468	1800mm without Core	22AWG for Vo: 5V 24AWG for Vo: 9V, 12V, 15V
	12A03	Φ5.5	Φ2.5	12			
	23A03	Φ5.5	Φ2.1	9.5			
	26A03	Φ5.5	Φ2.5	9.5			
 Right Angle/Inner+Outer- + ●) -	01A03	Φ5.5	Φ2.1	12			
	02A03	Φ5.5	Φ2.5	12			
	21A03	Φ5.5	Φ2.5	9.5			
	24A03	Φ5.5	Φ2.1	9.5			
 Straight/Inner+Outer- + ●) -	11E03	Φ5.5	Φ2.1	12	UL2468	1800mm without Core	22AWG for Vo: 5V 24AWG for Vo: 9V, 12V, 15V
	12E03	Φ5.5	Φ2.5	12			
	23E03	Φ5.5	Φ2.1	9.5			
	26E03	Φ5.5	Φ2.5	9.5			
 Right Angle/Inner+Outer- + ●) -	01E03	Φ5.5	Φ2.1	12			
	02E03	Φ5.5	Φ2.5	12			
	21E03	Φ5.5	Φ2.5	9.5			
	24E03	Φ5.5	Φ2.1	9.5			

※Other DC Plug Type please refer to the link: <https://www.cincon.com/productdownload/TRE06-cable-DC-Plug.pdf>

CINCON Electronics Co. Ltd.

Add: 14F, No. 306, Sec.4, Hsin Yi Rd., Taipei, Taiwan

Tel: 886-2-27086210

Fax: 886-2-27029852

E-mail: sales@cincon.com.tw

Web: www.cincon.com