



# SIP05-05S33A, SMT05-05S33A

Application Note Ver11 July 2005

## NON-ISOLATED DC-DC Converter

SIP05-05S33A, SMT05-05S33A  
3.0-5.5Vin, 0.75- 3.63Vout, 5A

### APPLICATION NOTE Ver11

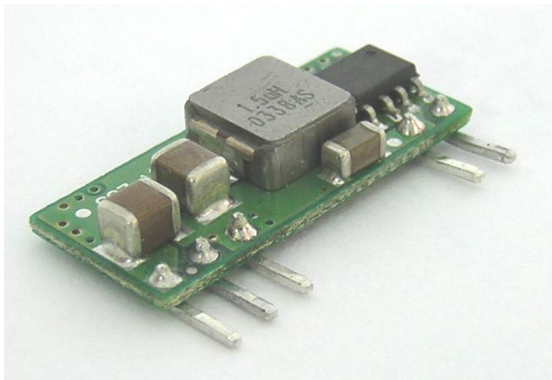

SIP05-05S33A

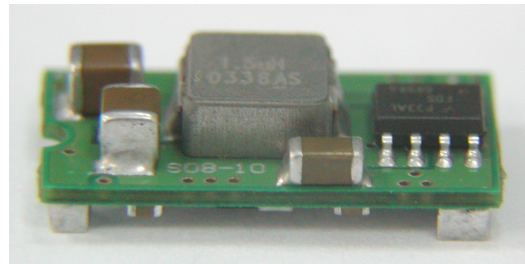

SMT05-05S33A

#### DOCUMENT HISTORY

VERSION	DATE	SUMMARY of CHANGE
Ver10	03/15/04	New Release
Ver11	07/15/05	Add Technical Specifications



# SIP05-05S33A, SMT05-05S33A

## Application Note Ver11 July 2005

---

### Content

<b>1. INTRODUCTION</b>	<b>3</b>
<b>2. 5A SIP/SMT CONVERTER FEATURES</b>	<b>3</b>
<b>3. GENERAL DESCRIPTION</b>	<b>3</b>
3.1 Electrical Description	3
3.2 Thermal Packaging and Physical Design.	3
<b>4. TECHNICAL SPECIFICATIONS</b>	<b>4</b>
<b>5. MAIN FEATURES AND FUNCTIONS</b>	<b>6</b>
5.1 Operating Temperature Range	6
5.2 Over-Temperature Protection (OTP)	6
5.3 Output Voltage Adjustment	6
5.4 Safe Operating Area (SOA)	6
5.5 Over Current Protection	6
5.6 Remote ON/OFF	6
5.7 UVLO (Under-Voltage Lockout)	7
<b>6. SAFETY</b>	<b>7</b>
6.1 Input Fusing and Safety Considerations.	7
<b>7. APPLICATIONS</b>	<b>7</b>
7.1 Layout Design Challenges.	7
7.2 Convection Requirements for Cooling	8
7.3 Thermal Considerations	8
7.4 Power De-Rating Curves	9
7.5 Efficiency vs Load Curves	13
7.6 Input Capacitance at the Power Module	15
7.7 Test Set-Up	15
7.8 SIP/SMT05-05 Series Output Voltage Adjustment.	16
7.9 Output Ripple and Noise Measurement	16
7.10 Output Capacitance	16
7.11 SMT Reflow Profile	16
<b>8. MECHANICAL OUTLINE DIAGRAMS</b>	<b>17</b>
8.1 SIP/SMT05 Mechanical Outline Diagrams	17
8.2 SMT Tape and Reel Dimensions	17



# SIP05-05S33A, SMT05-05S33A

## Application Note Ver11 July 2005

### 1. Introduction

This application note describes the features and functions of Cincon's SIP/SMT05-05 series of Non Isolated DC-DC Converters. These are highly efficient, reliable and compact, high power density, single output DC/DC converters. These "Point of Load" modules serve the needs specifically of the fixed and mobile telecommunications and computing market, employing economical distributed Power Architectures. The SIP/SMT05-05 series provide precisely regulated output voltage range from 0.75V to 3.63Vdc over a wide range of input voltage ( $V_i=3.0 - 5.5Vdc$ ) and can operate over an ambient temperature range of  $-40^{\circ}C$  to  $+85^{\circ}C$ . Ultra-high efficiency operation is achieved through the use of synchronous rectification and drive control techniques.

The modules are fully protected against short circuit and over-temperature conditions. Cincon's world class automated manufacturing methods, together with an extensive testing and qualification program, ensure that all SIP/SMT05-05 series converters are extremely reliable.

### 2. 5A SIP/SMT Converter Features

- High efficiency topology, typically 94% at 3.3Vdc
- Industry standard footprint
- Wide ambient temperature range,  $-40C$  to  $+85C$
- Cost efficient open frame design
- Programmable output voltage via external resistor from 0.75 to 3.63Vdc
- No minimum load requirement (Stable at all loads)
- Remote ON/OFF
- Remote sense compensation
- Fixed switching frequency
- Continuous short-circuit protection and over current protection
- Over-temperature protection (OTP)
- Monotonic Startup with pre-bias at the output.
- UL/IEC/EN60950 Certified.

### 3. General Description

#### 3.1 Electrical Description

A block diagram of the SIP/SMT05-05 Series converter is shown in Figure 1. Extremely high efficiency power conversion is achieved through the use of synchronous rectification and drive techniques. Essentially, the powerful SIP/SMT05-05 series topology is based on a non-isolated synchronous buck converter. The control loop is optimized for unconditional stability, fast transient response and a very tight line and load regulation. In a typical pre-bias application the SIP/SMT05-05 series converters do not draw any reverse current at start-up. The output voltage can be adjusted from 0.75 to 3.63vdc, using the TRIM pin with a external resistor. The converter can be shut down via a remote ON/OFF input that is referenced to ground. This input is compatible with popular logic devices; a 'positive' logic input is supplied as standard. Positive logic implies that the converter is enabled if the remote ON/OFF input is high (or floating), and disabled if it is low.

The converter is also protected against over-temperature conditions. If the converter is overloaded or the ambient temperature gets too high, the converter will shut down to protect the unit.

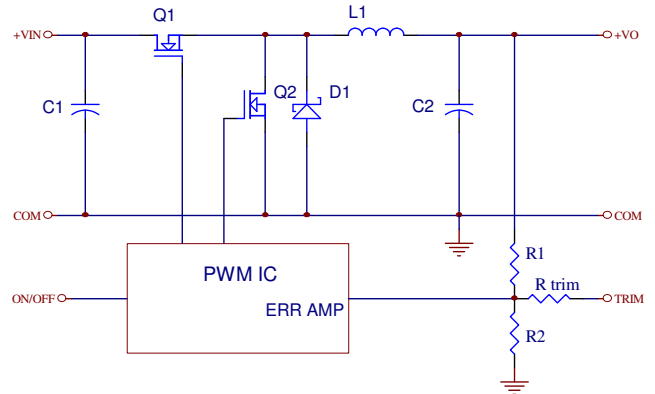

Figure 1. Electrical Block Diagram

#### 3.2 Thermal Packaging and Physical Design.

The SIP/SMT05-05 series uses a multi-layer FR4 PCB construction. All surface mount power components are placed on one side of the PCB, and all low-power control components are placed on the other side. Thus, the Heat dissipation of the power components is optimized, ensuring that control components are not thermally stressed. The converter is an open-frame product and has no case or case pin. The open-frame design has several advantages over encapsulated closed devices. Among these advantages are:

- **Efficient Thermal Management:** the heat is removed from the heat generating components without heating more sensitive, small signal control components.
- **Environmental:** Lead free open-frame converters are more easily re-cycled.
- **Cost Efficient:** No encapsulation. Cost efficient open-frame construction.
- **Reliable:** Efficient cooling provided by open frame construction offers high reliability and easy diagnostics.



# SIP05-05S33A, SMT05-05S33A

## Application Note Ver11 July 2005

### 4. Technical Specifications

(All specifications are typical at nominal input, full load at 25°C unless otherwise noted.)

PARAMETER	NOTES and CONDITIONS	Device	Min.	Typical	Max.	Units
<b>ABSOLUTE MAXIMUM RATINGS</b>						
Input Voltage Continuous		ALL	0		5.8	Vdc
Operating Temperature See Thermal Considerations Section		ALL	-40		+85	°C
Storage Temperature		ALL	-55		+125	°C
<b>INPUT CHARACTERISTICS</b>						
Operating Input Voltage	$V_{o,set} \leq V_{in} - 0.5V_{dc}$	ALL	3.0	5	5.5	Vdc
Input Under-Voltage Lockout						
Turn-On Voltage Threshold		ALL		2.0		Vdc
Turn-Off Voltage Threshold		ALL		1.9		Vdc
Lockout Hysteresis Voltage		ALL		0.1		Vdc
Maximum Input Current	$V_{in} = 0$ to 5.5Vdc , $I_o = I_{o,max}$ .	ALL			5	A
No-Load Input Current	$V_o = 0.75V$ $V_o = 1.2V$ $V_o = 1.5V$ $V_o = 1.8V$ $V_o = 2.0V$ $V_o = 2.5V$ $V_o = 3.3V$	ALL		25 30 30 35 35 35 35		mA
Off Converter Input Current	Shutdown input idle current	ALL			10	mA
Inrush Current ( $I^2t$ )		ALL			0.1	A <sup>2</sup> s
Input Reflected-Ripple Current	P-P thru 1uH inductor, 5Hz to 20MHz	ALL		150		mA
<b>OUTPUT CHARACTERISTIC</b>						
Output Voltage Set Point	$V_{in} = \text{Nominal } V_{in}$ , $I_o = I_{o,max}$ , $T_c = 25^\circ C$	ALL	-1.5%	$V_{o,set}$	+1.5%	Vdc
Output Voltage Trim Adjustment Range	Selected by an external resistor	ALL	0.75		3.63	Vdc
Output Voltage Regulation						
Load Regulation	$I_o = I_{o,min}$ to $I_{o,max}$	ALL	-0.5		+0.5	%
Line Regulation	$V_{in} = \text{low line to high line}$	ALL	-0.4		+0.4	%
Temperature Coefficient	$T_a = -40^\circ C$ to $85^\circ C$	ALL	-0.03		+0.03	%/°C
Output Voltage Ripple and Noise	5Hz to 20MHz bandwidth					
Peak-to-Peak	Full Load, 1uF ceramic and 10uF tantalum	ALL			50	mV
RMS	Full Load, 1uF ceramic and 10uF tantalum	ALL			20	mV
External Capacitive Load	Low ESR	ALL			3000	uF
Operating Output Current Range		ALL	0		5	A
Output DC Current-Limit Inception	Output Voltage = 90% Nominal Output Voltage	ALL	6	9.5	15	A
Shout Circuit Protection	Continuous with Hiccup Mode					



# SIP05-05S33A, SMT05-05S33A

## Application Note Ver11 July 2005

PARAMETER	NOTES and CONDITIONS	Device	Min.	Typical	Max.	Units
<b>DYNAMIC CHARACTERISTICS</b>						
Output Voltage Transient Response						
Error Band	50% Step Load Change, di/dt=0.1A/us	ALL			200	mV
Setting Time (within 1% Vout nominal)	50% Step Load Change, di/dt=0.1A/us	ALL			200	us
<b>EFFICIENCY</b>						
100% Load	Vo=0.75V Vo=1.2V Vo=1.5V Vo=1.8V Vo=2.0V Vo=2.5V Vo=3.3V	ALL		79 85 87 89 90 92 94		%
<b>ISOLATION CHARACTERISTICS</b>						
Input to Output	Non-isolation	ALL	0			Vdc
<b>FEATURE CHARACTERISTICS</b>						
Switching Frequency		ALL		300		KHz
ON/OFF Control, Positive Logic Remote On/Off Logic Low (Module Off) Logic High (Module On)	or Open Circuit	Standard Model	0	Vin	0.4	Vdc Vdc
ON/OFF Control, Negative Logic Remote On/Off Logic Low (Module On) Logic High (Module Off)	or Open Circuit	Suffix "N" Model	0 2.8		0.4 Vin	Vdc Vdc
ON/OFF Current (for both remote on/off logic)	Ion/off at Von/off=0.0V	ALL			1	mA
Leakage Current (for both remote on/off logic)	Logic High, Von/off=14V	ALL			1	mA
<b>Turn-On Delay and Rise Time</b>						
Turn-On Delay Time, From On/Off Control	Von/off to 10%Vo,set	ALL		2		ms
Turn-On Delay Time, From Input	Vin,min. to 10%Vo,set	ALL		2		ms
Output Voltage Rise Time	10%Vo,set to 90%Vo,set	ALL		4.5		ms
Over Temperature Protection		ALL		120		°C
<b>GENERAL SPECIFICATIONS</b>						
MTBF	Io=100%of Io,max;Ta=25°C per MIL-HDBK-217F	ALL		1.5		M hours
Weight		ALL		2.3		grams
<b>Dimensions</b>						
SIP packages	0.9x0.4x0.22 inches (22.9x10.16x5.6 mm)					
SMT packages	0.8x0.45x0.24 inches(20.3x11.43x6.09 mm)					



# SIP05-05S33A, SMT05-05S33A

## Application Note Ver11 July 2005

### 5. Main Features and Functions

#### 5.1 Operating Temperature Range

Cincon's SIP/SMT05-05 series converters highly efficient converter design has resulted in its ability to operate over a wide ambient temperature environment (  $-40^{\circ}\text{C}$  to  $85^{\circ}\text{C}$  ). Due consideration must be given to the de-rating curves when ascertaining maximum power that can be drawn from the converter. The maximum power drawn is influenced by a number of factors, such as:

- Input voltage range.
- Output load current.
- Air velocity (forced or natural convection).
- Mounting orientation of converter PCB with respect to the Airflow.
- Motherboard PCB design, especially ground and power planes.

These can be effective heat sinks for the converter.

#### 5.2 Over-Temperature Protection (OTP)

The SIP/SMT05-05 Series converters are equipped with non-latching over-temperature protection. A temperature sensor monitors the temperature of the hot spot (typically, top switch). If the temperature exceeds a threshold of  $120^{\circ}\text{C}$  (typical) the converter will shut down, disabling the output. When the temperature has decreased the converter will automatically restart.

The over-temperature condition can be induced by a variety of reasons such as external overload condition or a system fan failure.

#### 5.3 Output Voltage Adjustment

Section 7.8 describes in detail as to how to trim the output voltage with respect to its set point. The output voltage on all models is trimmable in the range 0.75 – 3.63Vdc.

#### 5.4 Safe Operating Area (SOA)

Figure 2 provides a graphical representation of the Safe Operating Area (SOA) of the converter. This representation assumes ambient operating conditions such as airflow are met as per thermal guidelines provided in Sections 7.2 and 7.3.

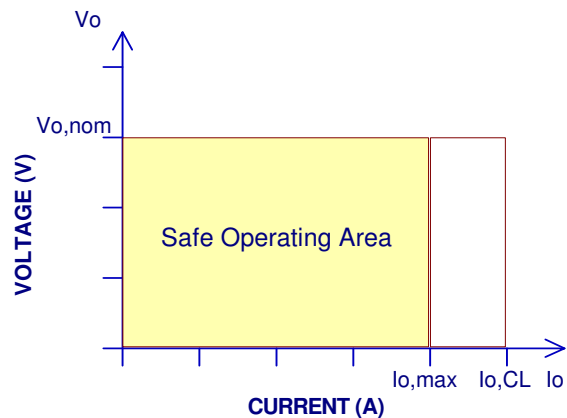

Figure 2. Maximum Output Current Safe Operating Area

#### 5.5 Over Current Protection

All different voltage models have a full continuous short-circuit protection. The unit will auto recover once the short circuit is removed. To provide protection in a fault condition, the unit is equipped with internal over-current protection. The unit operates normally once the fault condition is removed. The power module will supply up to 150% of rated current. In the event of an over current converter will go into a hiccup mode protection.

#### 5.6 Remote ON/OFF

The remote ON/OFF input feature of the converter allows external circuitry to turn the converter ON or OFF. Active-high remote ON/OFF is available as standard. The SIP/SMT05-05 series converters are turned on if the remote ON/OFF pin is high, or left open or floating. Setting the pin low will turn the converter 'Off'. The signal level of the remote on/off input is defined with respect to ground. If not using the remote on/off pin, leave the pin open (module will be on). The part number suffix "N" is Negative remote ON/OFF version. The unit is guaranteed OFF over the full temperature range if this voltage level exceeds 2.8Vdc. The converters are turned on If the on/off pin input is low or left open. The recommended SIP/SMT remote on/off drive circuit as shown as figure 3, 4.



# SIP05-05S33A, SMT05-05S33A

## Application Note Ver11 July 2005

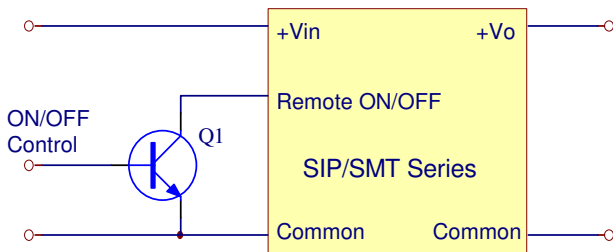

Figure 3. Positive Remote ON/OFF Input Drive Circuit

through connecting pins. The system designer or the end user must ensure that other components and metal in the vicinity of the SIP/SMT05-05 series meet the spacing requirements to which the system is approved.

Low resistance and low inductance PCB layout traces are the norm and should be used where possible. Due consideration must also be given to proper low impedance tracks between power module, input and output grounds. The recommended SIP/SMT footprint as shown as figure 5, 6.

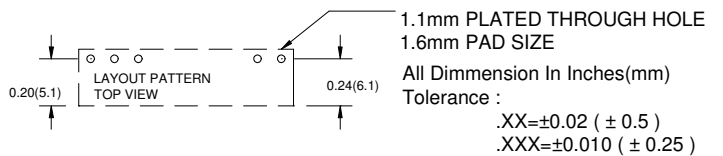

Figure 5. Recommended SIP Footprint

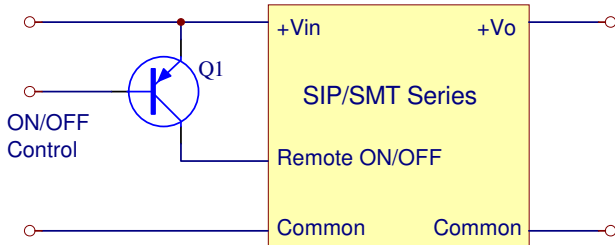

Figure 4. Negative Remote ON/OFF Input Drive Circuit

### 5.7 UVLO (Under-Voltage Lockout)

The voltage on the Vcc pin determines the start of the operation of the Converter. When the input Vcc rises and exceeds about 2.0V the converter initiates a soft start. The UVLO function in the converter has a hysteresis (about 100mV) built in to provide noise immunity at start-up.

## 6. Safety

### 6.1 Input Fusing and Safety Considerations.

**Agency Approvals:** The power Supply shall be submitted to and receive formal approval from the following test agencies.

1. The power supply shall be approved by a nationally recognized testing laboratory to UL/CSA 60950 3<sup>rd</sup> Edition (North America) and EN60950 (International)

2. CB Certificate from an internationally recognized test house in accordance with EN 60950.

The SIP/SMT05-05 series converters do not have an internal fuse. However, to achieve maximum safety and system protection, always use an input line fuse. The safety agencies require a time-delay fuse with a maximum rating of 10A.

## 7. Applications

### 7.1 Layout Design Challenges.

In optimizing thermal design the PCB is utilized as a heat sink. Also some heat is transferred from the SIP/SMT module to the main board

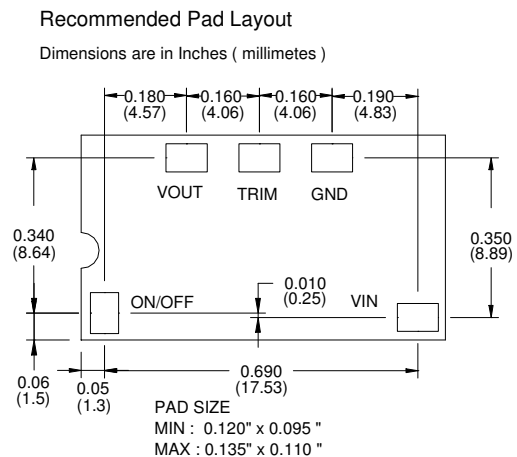

Figure 6. Recommended SMT Footprint (Top View)



# SIP05-05S33A, SMT05-05S33A

## Application Note Ver11 July 2005

### 7.2 Convection Requirements for Cooling

To predict the approximate cooling needed for the module, refer to the Power De-rating curves in Figures 10 to 13. These de-rating curves are approximations of the ambient temperatures and airflows required to keep the power module temperature below its maximum rating. Once the module is assembled in the actual system, the module's temperature should be checked as shown in Figure 7 to ensure it does not exceed 110°C.

Proper cooling can be verified by measuring the power module's temperature at Q1-pin 6 as shown in Figure 8,9.

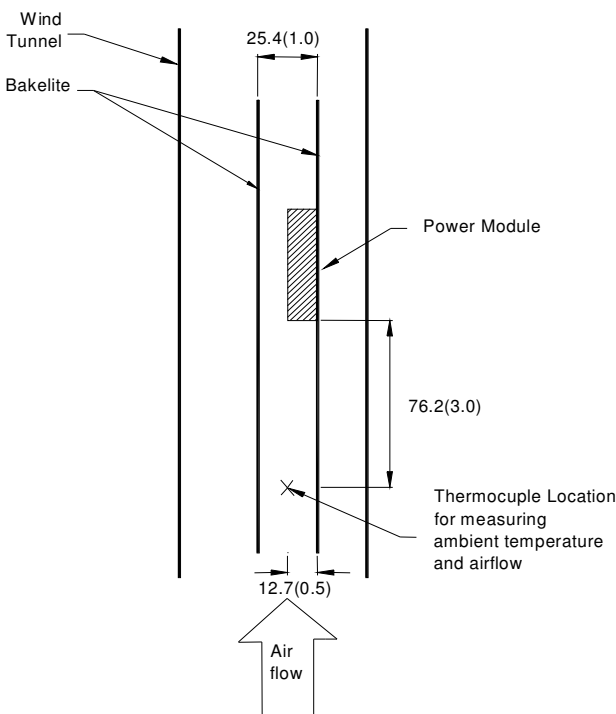

Note : Dimensions are in millimeters and (inches)

Figure 7. Thermal Test Setup

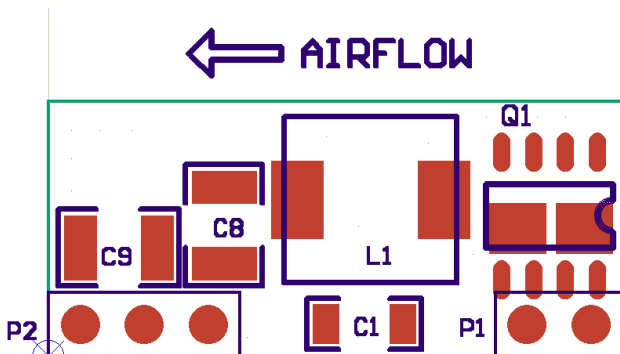

Figure 8. Temperature Measurement Location for SIP

← AIR FLOW

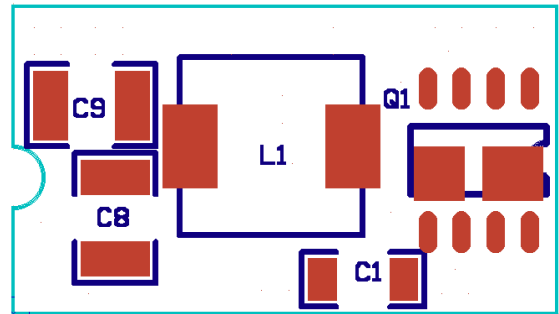

Figure 9. Temperature Measurement Location for SMT

### 7.3 Thermal Considerations

The power module operates in a variety of thermal environments; however, sufficient cooling should be provided to help ensure reliable operation of the unit. Heat is removed by conduction, convection, and radiation to the surrounding environment. The thermal data presented is based on measurements taken in a set-up as shown in Figure 7. Figures 10 to 13 represent the test data. Note that the airflow is parallel to the long axis of the module as shown in Figure 7 for the SIP/SMT. The temperature at either location should not exceed 110 °C. The output power of the module should not exceed the rated power for the module (VO, set x IO, max). The SMT05 thermal data presented is based on measurements taken in a wind tunnel. The test setup shown in Figure 7 and EUT need to solder on 33mm x 40.38mm(1.300" x 1.59") test pcb. Note that airflow is parallel to the long axis of the module as shown in Fig7.





# SIP05-05S33A, SMT05-05S33A

## Application Note Ver11 July 2005

### 7.4 Power De-Rating Curves

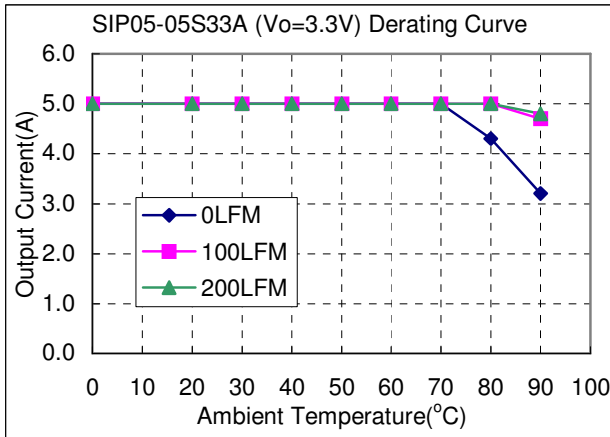

Figure10a. Typical Power De-rating for 5.0V IN 3.3Vout

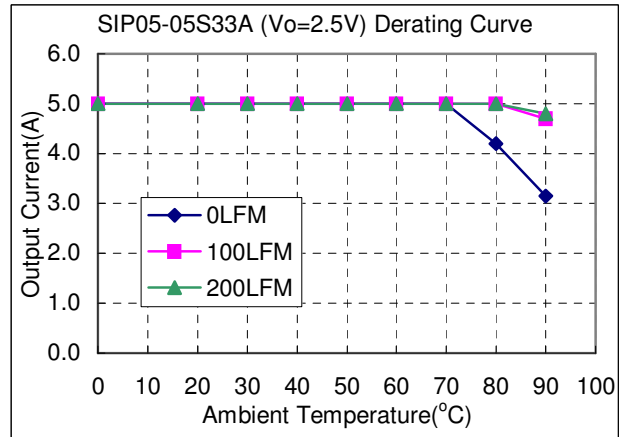

Figure 10b. Typical Power De-rating for 5.0V IN 2.5Vout

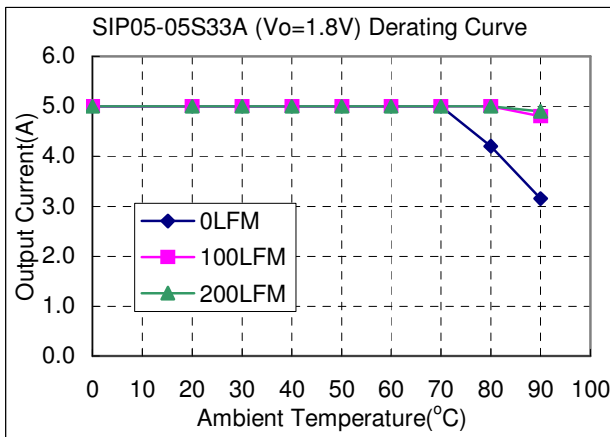

Figure10c. Typical Power De-rating for 5.0V IN 1.8Vout

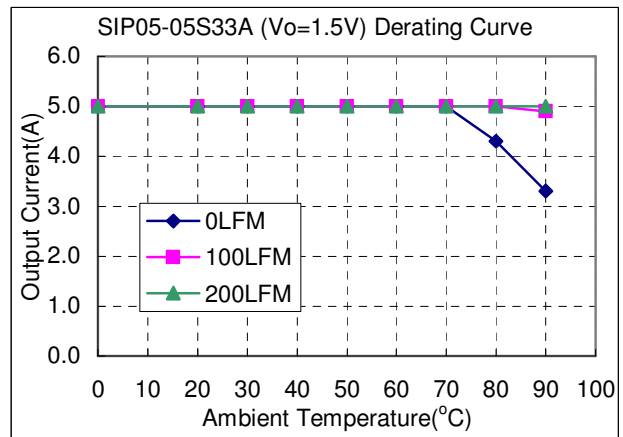

Figure 10d. Typical Power De-rating for 5.0V IN 1.5Vout

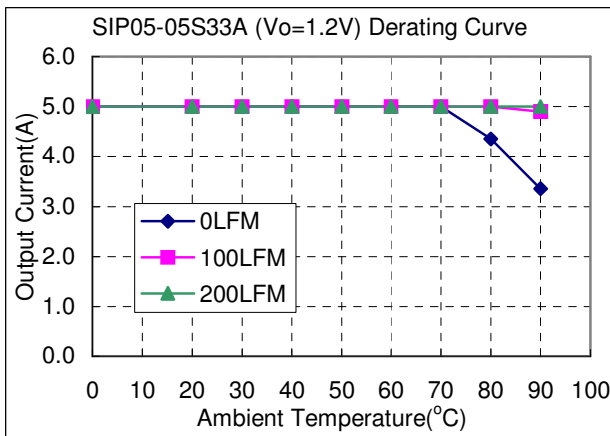

Figure10e. Typical Power De-rating for 5.0V IN 1.2Vout

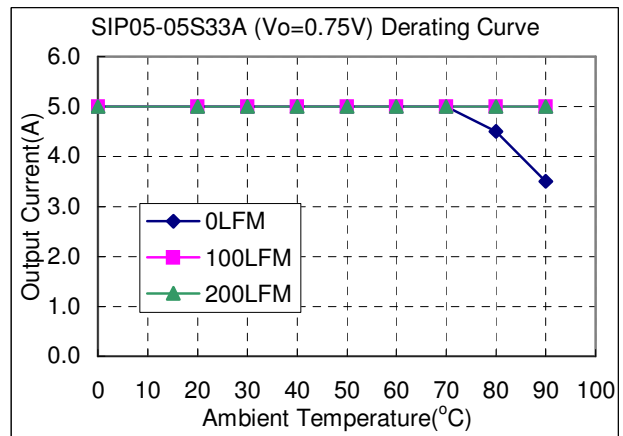

Figure 10f. Typical Power De-rating for 5.0V IN 0.75Vout



# SIP05-05S33A, SMT05-05S33A

## Application Note Ver11 July 2005

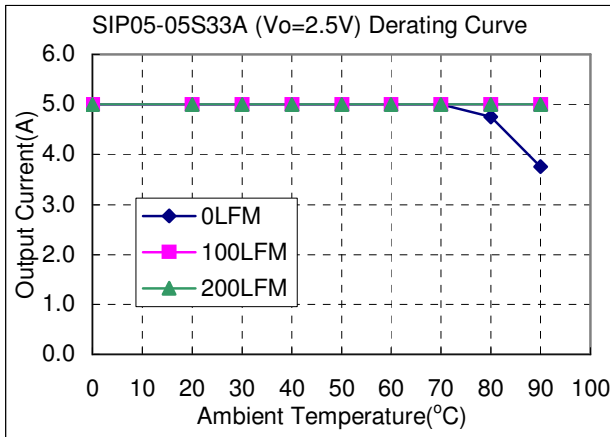

Figure 11a. Typical Power De-rating for 3.3V IN 2.5Vout

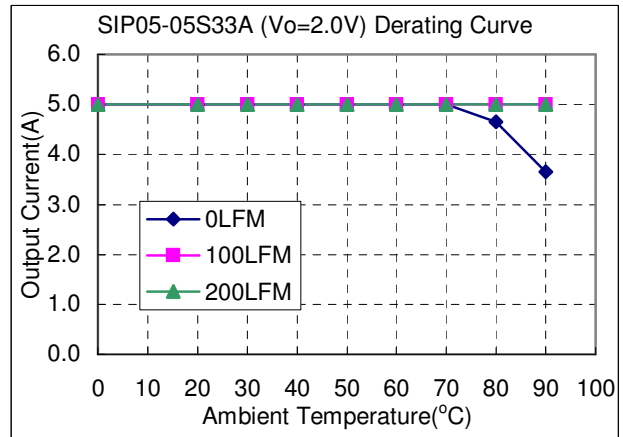

Figure 11b. Typical Power De-rating for 3.3V IN 2.0Vout

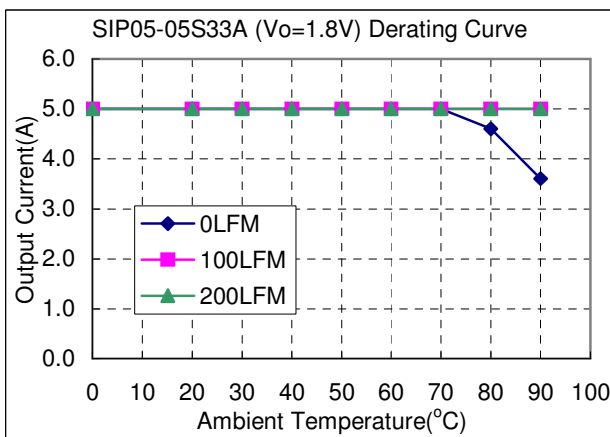

Figure 11c. Typical Power De-rating for 3.3V IN 1.8Vout

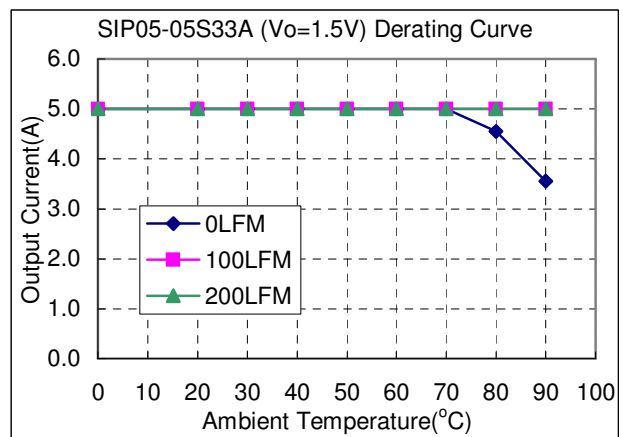

Figure 11d. Typical Power De-rating for 3.3V IN 1.5Vout

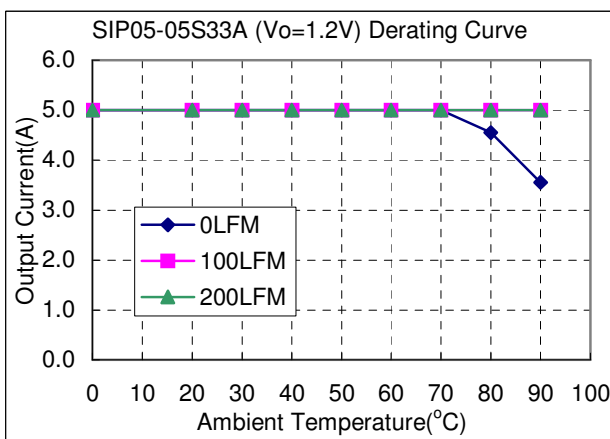

Figure 11e. Typical Power De-rating for 3.3V IN 1.2Vout

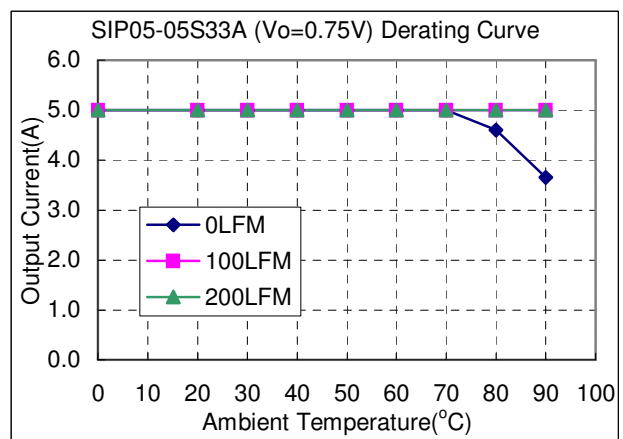

Figure 11f. Typical Power De-rating for 3.3V IN 0.75Vout



# SIP05-05S33A, SMT05-05S33A

## Application Note Ver11 July 2005

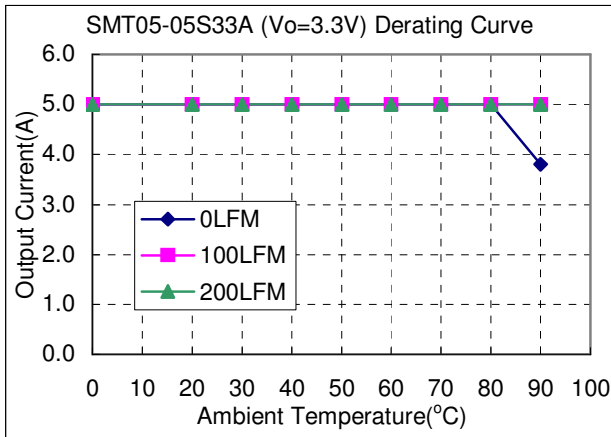

Figure12a. Typical Power De-rating for 5V IN 3.3Vout

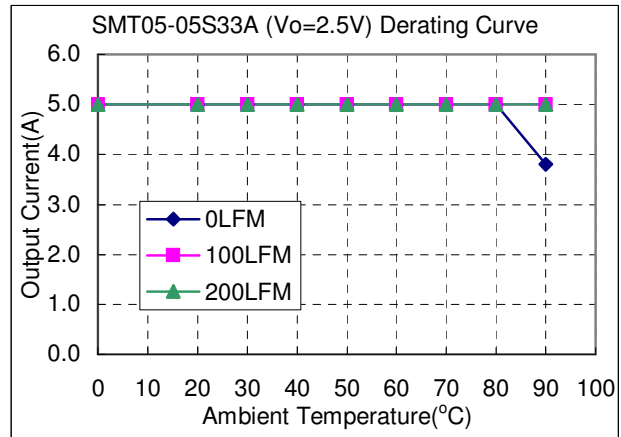

Figure12b. Typical Power De-rating for 5V IN 2.5Vout

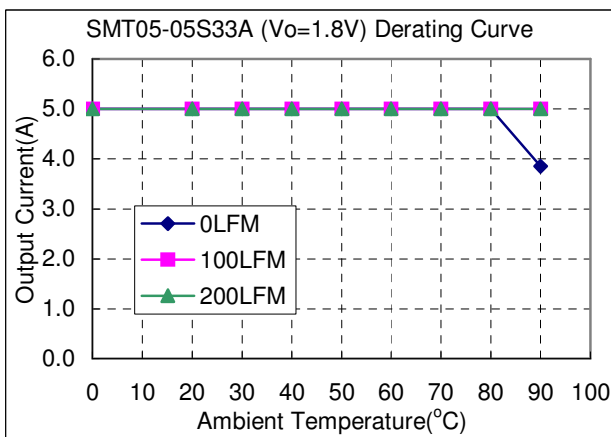

Figure12c. Typical Power De-rating for 5V IN 1.8Vout

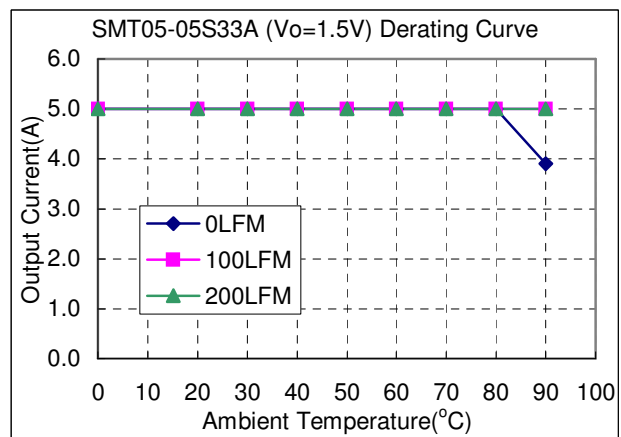

Figure 12d. Typical Power De-rating for 5V IN 1.5Vout

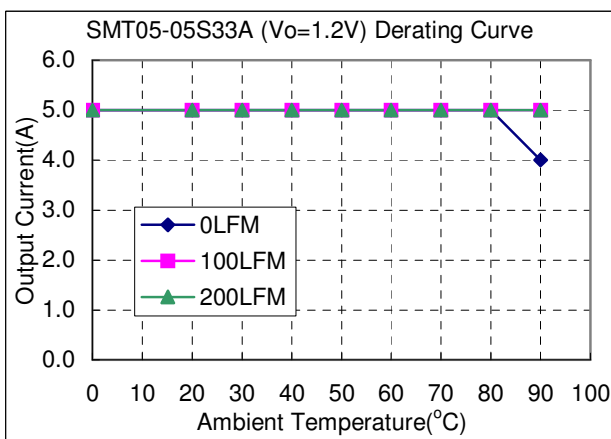

Figure12e. Typical Power De-rating for 5V IN 1.2Vout

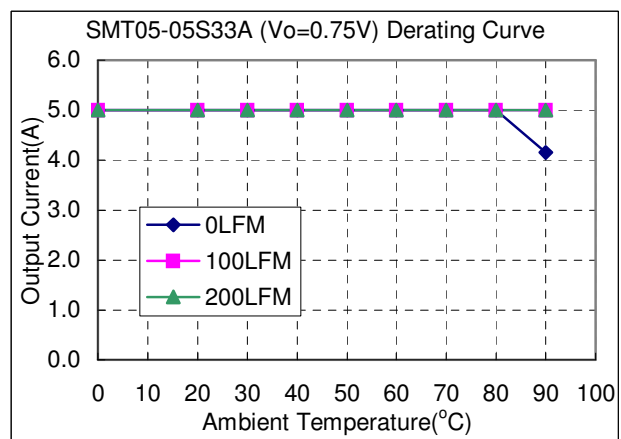

Figure 12f. Typical Power De-rating for 5V IN 0.75Vout



# SIP05-05S33A, SMT05-05S33A

## Application Note Ver11 July 2005

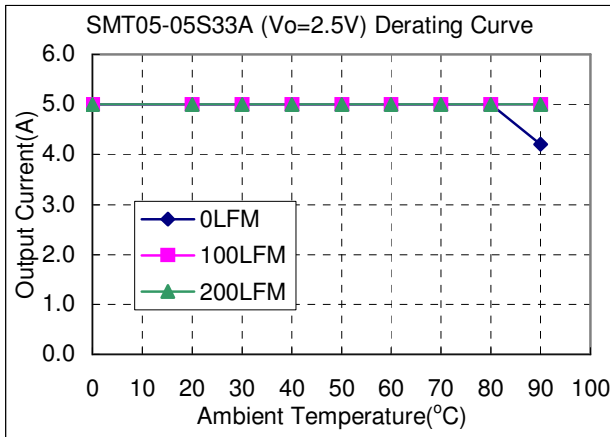

Figure13a. Typical Power De-rating for 3.3V IN 2.5Vout

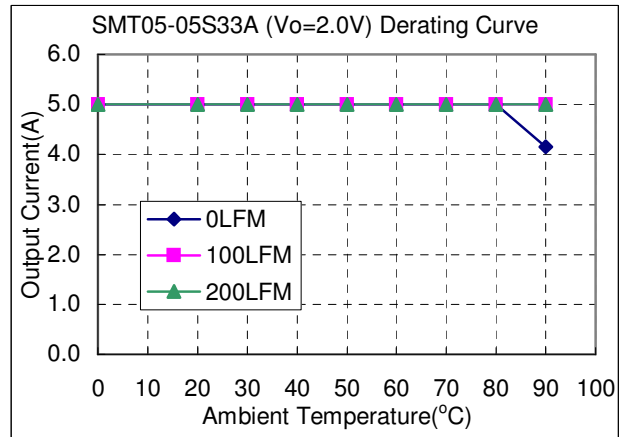

Figure 13b. Typical Power De-rating for 3.3V IN 2.0Vout

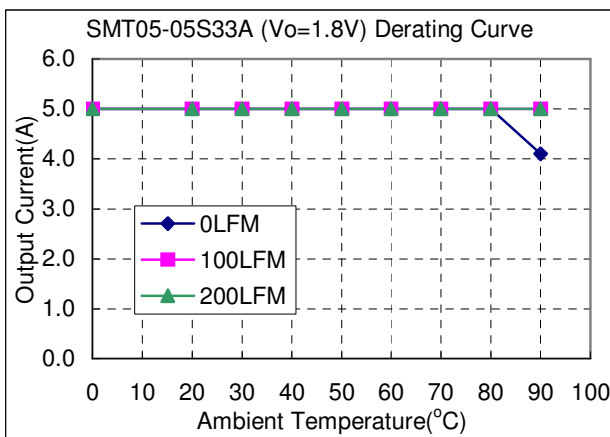

Figure13c. Typical Power De-rating for 3.3V IN 1.8Vout

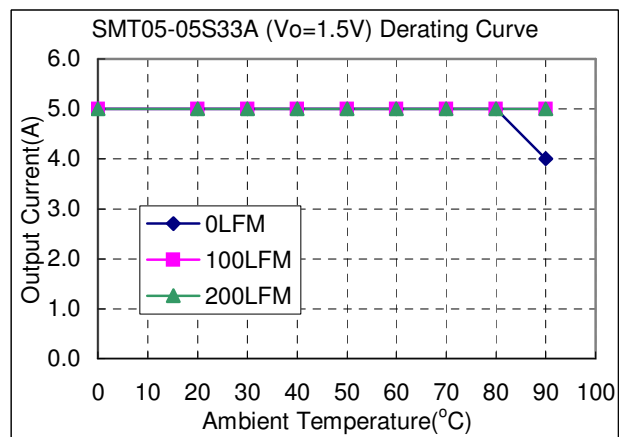

Figure 13d. Typical Power De-rating for 3.3V IN 1.5Vout

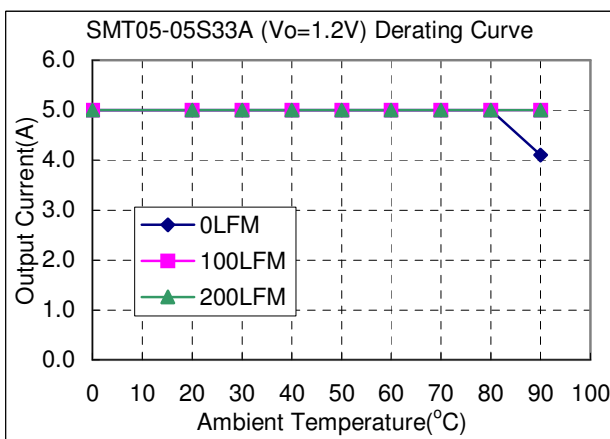

Figure13e. Typical Power De-rating for 3.3V IN 1.2Vout

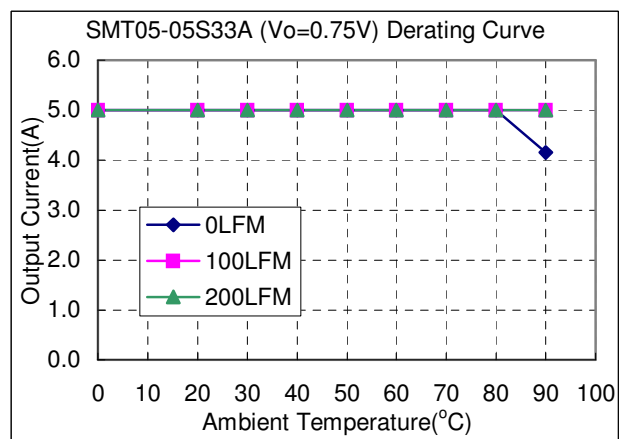

Figure 13f. Typical Power De-rating for 3.3V IN 0.75Vout



# SIP05-05S33A, SMT05-05S33A

## Application Note Ver11 July 2005

### 7.5 Efficiency vs Load Curves

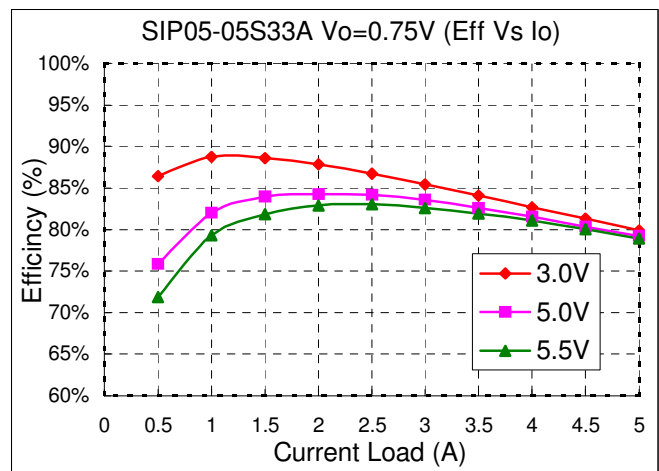
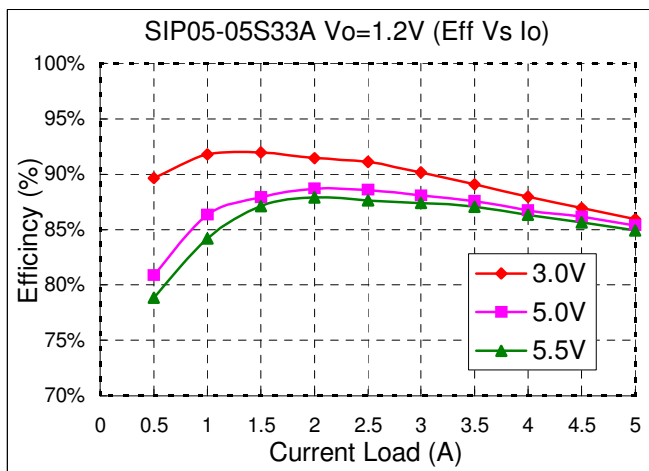
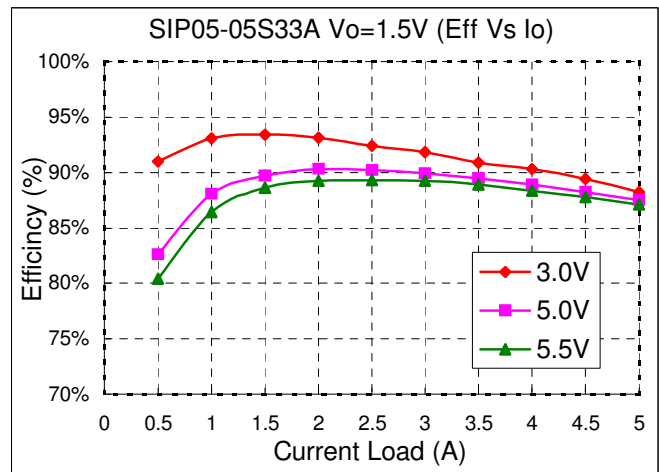
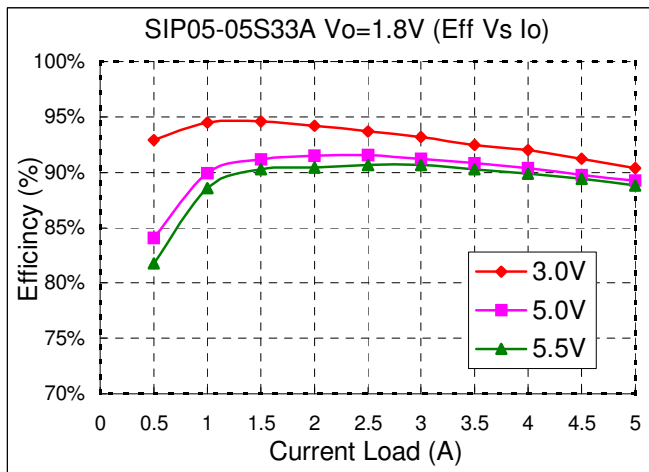
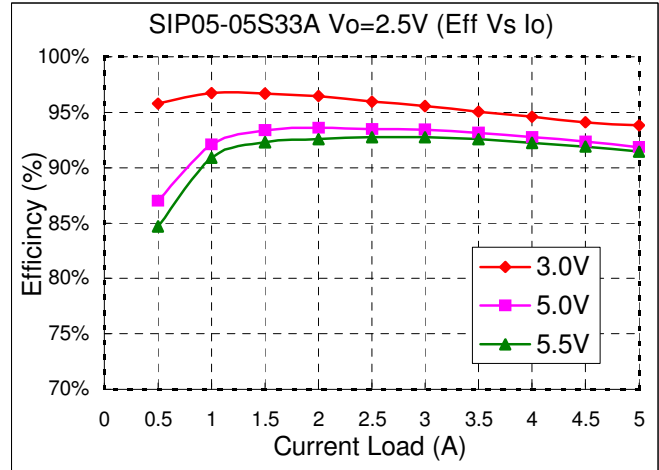
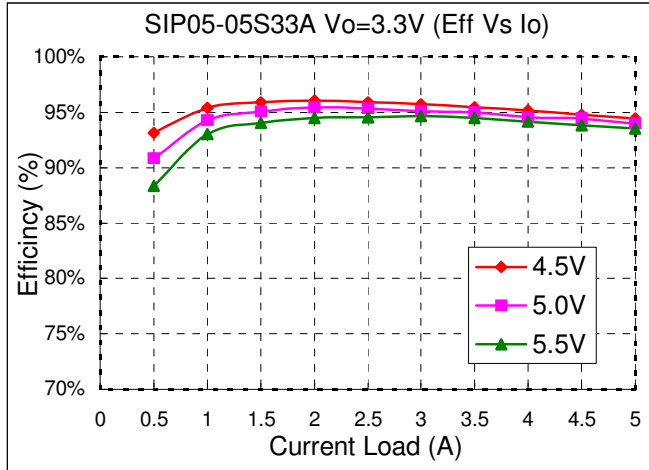



# SIP05-05S33A, SMT05-05S33A

## Application Note Ver11 July 2005

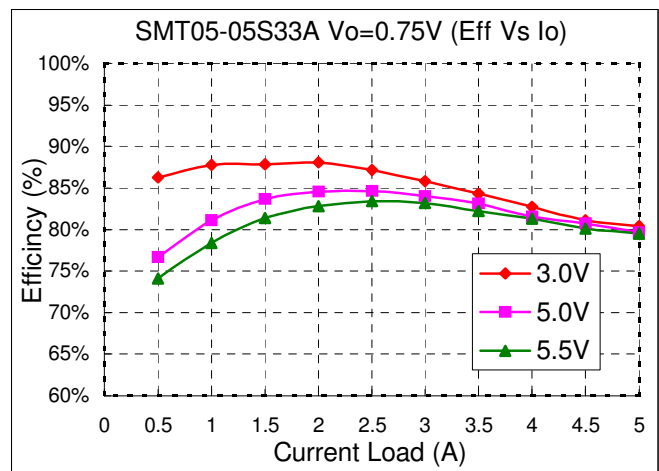
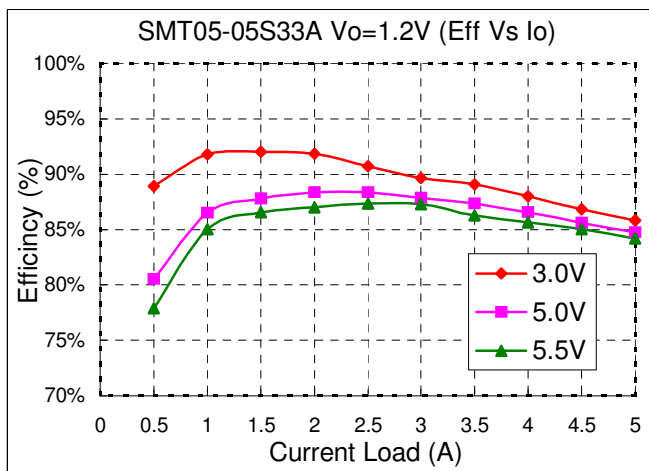
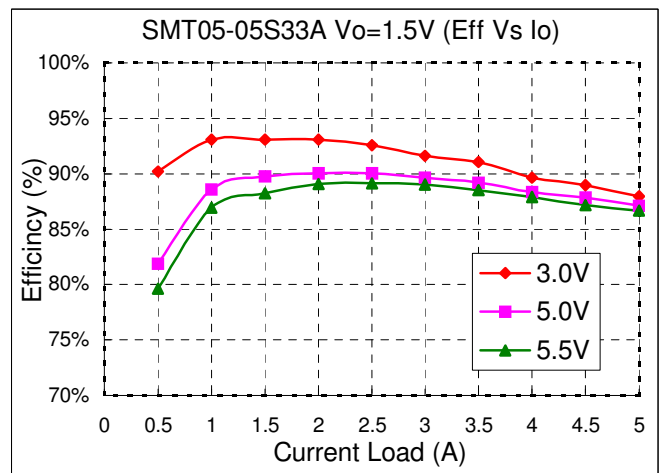
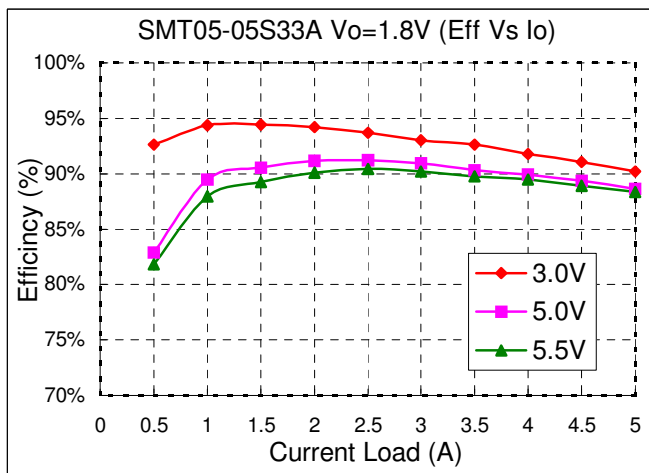
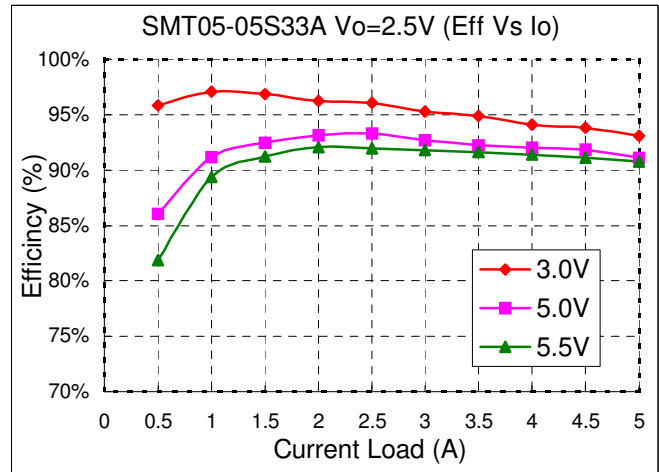
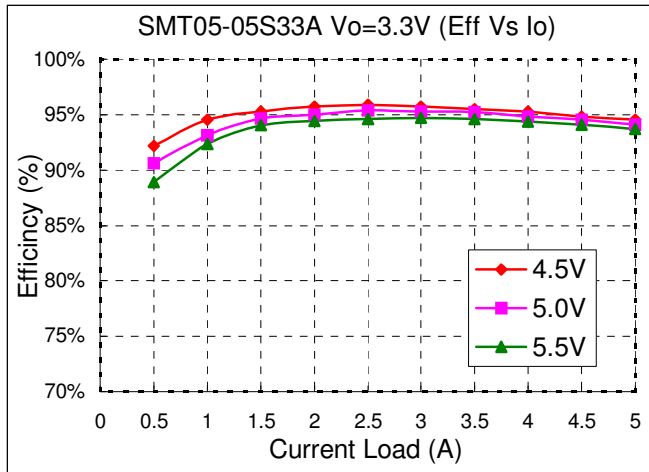



# SIP05-05S33A, SMT05-05S33A

## Application Note Ver11 July 2005

### 7.6 Input Capacitance at the Power Module

The SIP/SMT converters must be connected to a low AC source impedance. To avoid problems with loop stability source inductance should be low. Also, the input capacitors should be placed close to the converter input pins to de-couple distribution inductance. However, the external input capacitors are chosen for suitable ripple handling capability. Low ESR polymers are a good choice. They have high capacitance, high ripple rating and low ESR (typical <100mohm). Electrolytic capacitors should be avoided. Circuit as shown in Figure 14 represents typical measurement methods for ripple current. Input reflected-ripple current is measured with a simulated source Inductance of 1uH. Current is measured at the input of the module.

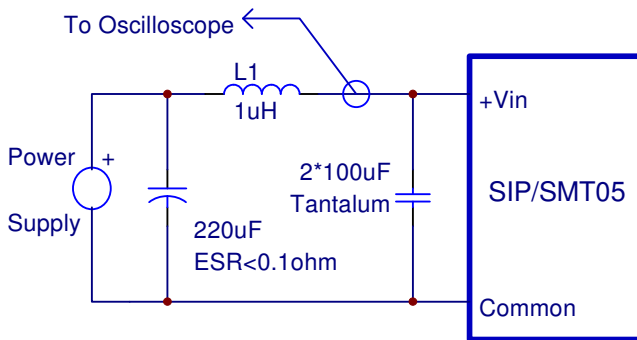

Figure 14. Input Reflected-Ripple Test Setup

### 7.7 Test Set-Up

The basic test set-up to measure parameters such as efficiency and load regulation is shown in Figure 15. Things to note are that this converter is non-isolated, as such the input and output share a common ground. These grounds should be connected together via low impedance ground plane in the application circuit. When testing a converter on a bench set-up, ensure that -Vin and -Vo are connected together via a low impedance short to ensure proper efficiency and load regulation measurements are being made. When testing the Cincon's SIP/SMT05-05 series under any transient conditions please ensure that the transient response of the source is sufficient to power the equipment under test. We can calculate the

- Efficiency
- Load regulation and line regulation.

The value of efficiency is defined as:

$$\eta = \frac{V_o \times I_o}{V_{in} \times I_{in}} \times 100\%$$

Where: Vo is output voltage,  
Io is output current,  
Vin is input voltage,  
Iin is input current.

The value of load regulation is defined as:

$$Load.reg = \frac{V_{FL} - V_{NL}}{V_{NL}} \times 100\%$$

Where: V<sub>FL</sub> is the output voltage at full load  
V<sub>NL</sub> is the output voltage at no load

The value of line regulation is defined as:

$$Line.reg = \frac{V_{HL} - V_{LL}}{V_{LL}} \times 100\%$$

Where: V<sub>HL</sub> is the output voltage of maximum input voltage at full load.  
V<sub>LL</sub> is the output voltage of minimum input voltage at full load.

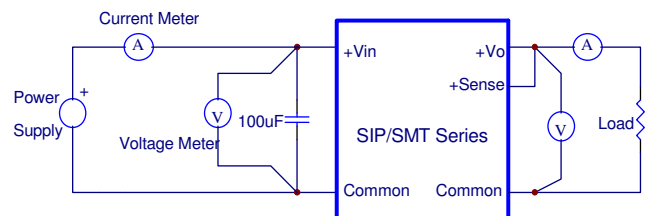

Figure 15. SIP/SMT05 Series Test Setup



# SIP05-05S33A, SMT05-05S33A

## Application Note Ver11 July 2005

### 7.8 SIP/SMT05-05 Series Output Voltage Adjustment.

The output Voltage of the SIP/SMT05-05S33A can be adjusted in the range 0.75V to 3.63V by connecting a single resistor on the motherboard (shown as Rtrim) in Figure 17. When Trim resistor is not connected the output voltage defaults to 0.75V

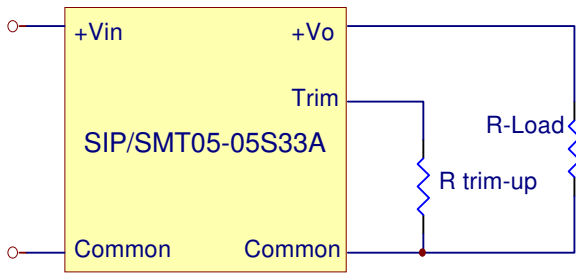

Figure 17. Trim-up Voltage Setup

The value of Rtrim-up defined as:

$$R_{trim} = \left( \frac{21070}{V_o - 0.75} - 5110 \right)$$

Where: Rtrim-up is the external resistor in ohm,

Vo is the desired output voltage

To give an example of the above calculation, to set a voltage of 3.3Vdc, Rtrim is given by:

$$R_{trim} = \left( \frac{21070}{V_o - 0.75} - 5110 \right)$$

Rtrim = 3153 ohm

For various output values various resistors are calculated and provided in Table 3 for convenience.

Vo,set (V)	Rtrim (Kohm)
0.75	Open
1.20	41.71
1.50	22.98
1.80	14.96
2.00	11.75
2.50	6.93
3.30	3.15
3.63	2.20

Table 3 – Trim Resistor Values

### 7.9 Output Ripple and Noise Measurement

The test set-up for noise and ripple measurements is shown in Figure 18. a coaxial cable with a 50ohm termination was used to prevent impedance mismatch reflections disturbing the noise readings at higher frequencies.

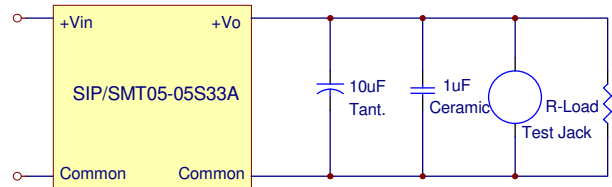

Figure 18. Output Voltage Ripple and Noise Measurement Set-Up

### 7.10 Output Capacitance

Cincon's SIP/SMT05-05 series converters provide unconditional stability with or without external capacitors. For good transient response low ESR output capacitors should be located close to the point of load. For high current applications point has already been made in layout considerations for low resistance and low inductance tracks. Output capacitors with its associated ESR values have an impact on loop stability and bandwidth. Cincon's converters are designed to work with load capacitance up-to 3,000uF. It is recommended that any additional capacitance, Maximum 3,000uF and low ESR, be connected close to the point of load and outside the remote compensation point.

### 7.11 SMT Reflow Profile

An example of the SMT reflow profile is given in Figure 19.

**Equipment used:** SMD HOT AIR REFLOW HD-350SAR

**Alloy:** AMQ-M293TA or NC-SMQ92 IND-82088 SN63

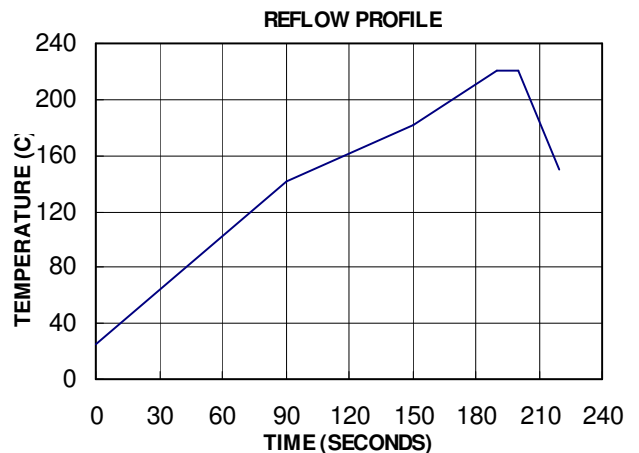

Figure 19 SMT Reflow Profile





# SIP05-05S33A, SMT05-05S33A

## Application Note Ver11 July 2005

### 8. Mechanical Outline Diagrams

#### 8.1 SIP/SMT05 Mechanical Outline Diagrams

Dimensions are in millimeters and inches

Tolerance: x.xx ±0.02 in. (0.5mm) , x.xxx ±0.010 in. (0.25 mm) unless otherwise noted

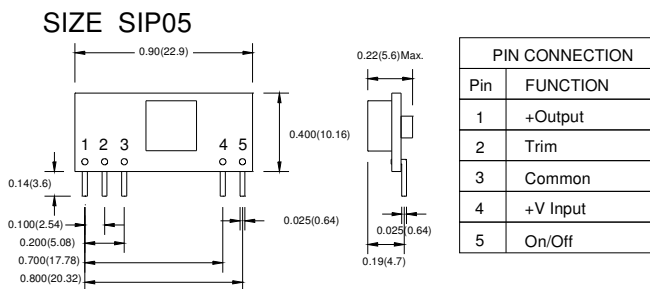

Figure 20 SIP05 Mechanical Outline Diagram

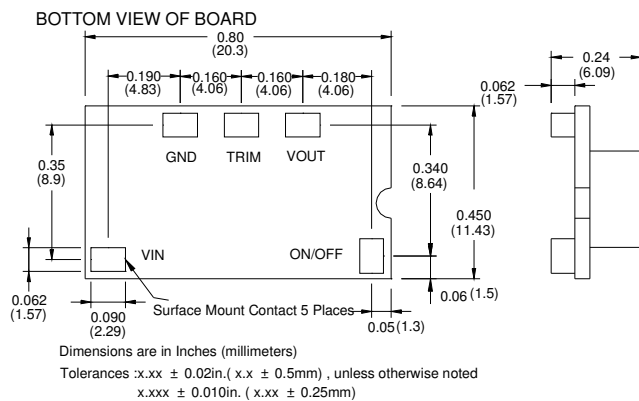
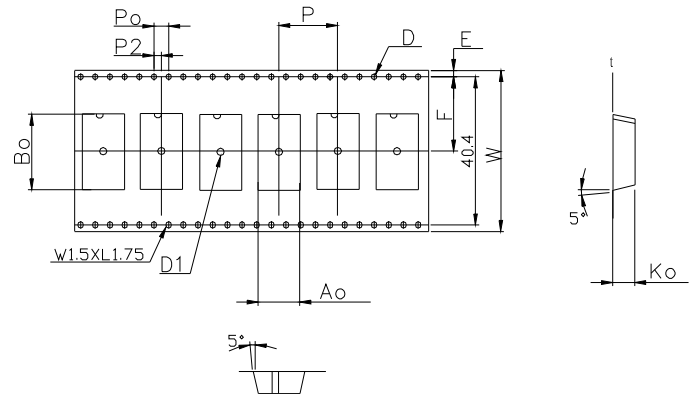

Figure 21 SMT05 Mechanical Outline Diagram

#### 8.2 SMT Tape and Reel Dimensions

The Tape Reel dimensions for the SMT module is shown in Figure 22.



ITEM	SPEC
W	44.00 <sup>+0.30</sup> <sub>-0.30</sub>
Ao	11.50 <sup>+0.10</sup> <sub>-0.10</sub>
Bo	20.70 <sup>+0.10</sup> <sub>-0.10</sub>
Ko	6.00 <sup>+0.10</sup> <sub>-0.10</sub>
P	16.00 <sup>+0.10</sup> <sub>-0.10</sub>
F	20.20 <sup>+0.10</sup> <sub>-0.10</sub>
E	1.75 <sup>+0.10</sup> <sub>-0.10</sub>
D	1.50 <sup>+0.10</sup> <sub>-0.00</sub>
D1	2.00 <sup>+0.25</sup> <sub>-0.00</sub>
Po	4.00 <sup>+0.10</sup> <sub>-0.10</sub>
P2	2.00 <sup>+0.10</sup> <sub>-0.10</sub>
t	0.35 <sup>+0.05</sup> <sub>-0.05</sub>

Figure 22 – SMT Tape and Reel Dimensions

## CINCON ELECTRONICS CO., LTD.

#### Headquarter Office:

14F, No.306, Sec.4, Hsin Yi Rd.,  
Taipei, Taiwan  
Tel: 886-2-27086210  
Fax: 886-2-27029852  
E-mail: [support@cincon.com.tw](mailto:support@cincon.com.tw)  
Web Site: <http://www.cincon.com>

#### Factory:

No. 8-1, Fu Kong Rd.,  
Fu Hsing Industrial Park  
Fu Hsing Hsiang, ChangHua Hsien,  
Taiwan  
Tel: 886-4-7690261  
Fax: 886-4-7698031

#### Cincon American Office:

7770 Telegraph Road, Suite 219,  
Ventura, CA 93004  
Tel: 805-647-3006  
Fax: 805-659-3372  
E-mail: [escherb@cincon.com](mailto:escherb@cincon.com)