



# SIP20W-12S05A, SMT20W-12S05A

Application Note Ver10 Feb 2005

## NON-ISOLATED DC-DC Converter SIP20W-12S05A, SMT20W-12S05A 6.0-14Vin, 0.75- 5.0Vout, 20A

### APPLICATION NOTE

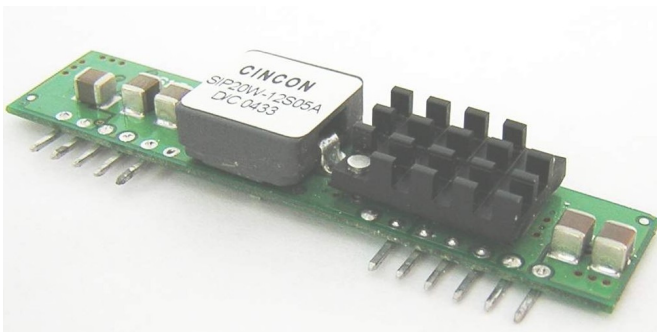

SIP20W-12S05A

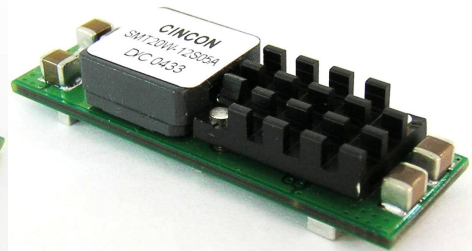

SMT20W-12S05A

#### DOCUMENT HISTORY

VERSION	DATE	SUMMARY of CHANGE
Ver10	02/24/05	New Release



# SIP20W-12S05A, SMT20W-12S05A

## Application Note Ver10 Feb 2005

---

### Content

<b>1. INTRODUCTION</b>	<b>3</b>
<b>2. 20A SIP/SMT CONVERTER FEATURES</b>	<b>3</b>
<b>3. GENERAL DESCRIPTION</b>	<b>3</b>
3.1 Electrical Description	3
3.2 Thermal Packaging and Physical Design.	3
<b>4. TECHNICAL SPECIFICATIONS</b>	<b>4</b>
<b>5. MAIN FEATURES AND FUNCTIONS</b>	<b>6</b>
5.1 Operating Temperature Range	6
5.2 Over-Temperature Protection (OTP)	6
5.3 Output Voltage Adjustment	6
5.4 Safe Operating Area (SOA)	6
5.5 Over Current Protection	6
5.6 Remote ON/OFF	6
5.7 UVLO (Under-Voltage Lockout)	7
5.8 Output Voltage Sequencing (Tracking)	7
<b>6. SAFETY</b>	<b>8</b>
6.1 Input Fusing and Safety Considerations.	8
<b>7. APPLICATIONS</b>	<b>8</b>
7.1 Layout Design Challenges.	8
7.2 Convection Requirements for Cooling	9
7.3 Thermal Considerations	9
7.4 Power De-Rating Curves	10
7.5 Efficiency vs Load Curves	13
7.6 Input Capacitance at the Power Module	16
7.7 Test Set-Up	16
7.8 Remote Sense Compensation	16
7.9 SIP/SMT20W-12 Series Output Voltage Adjustment.	17
7.10 Output Ripple and Noise Measurement	17
7.11 Output Capacitance	17
7.12 SMT Reflow Profile	17
<b>8. MECHANICAL OUTLINE DIAGRAMS</b>	<b>18</b>
8.1 SIP/SMT20W Mechanical Outline Diagrams	18
8.2 SMT Tape and Reel Dimensions	18



# SIP20W-12S05A, SMT20W-12S05A

## Application Note Ver10 Feb 2005

### 1. Introduction

This application note describes the features and functions of Cincon's SIP/SMT20W-12 series of Non Isolated DC-DC Converters. These are highly efficient, reliable and compact, high power density, single output DC/DC converters. These "Point of Load" modules serve the needs specifically of the fixed and mobile telecommunications and computing market, employing economical distributed Power Architectures. The SIP/SMT20W-12 series provide precisely regulated output voltage range from 0.7525V to 5.0Vdc over a wide range of input voltage ( $V_i=6.0 - 14Vdc$ ) and can operate over an ambient temperature range of  $-40^{\circ}C$  to  $+85^{\circ}C$ . Ultra-high efficiency operation is achieved through the use of synchronous rectification and drive control techniques. The modules are fully protected against short circuit and over-temperature conditions. Cincon's world class automated manufacturing methods, together with an extensive testing and qualification program, ensure that all SIP/SMT20W-12 series converters are extremely reliable.

### 2. 20A SIP/SMT Converter Features

- High efficiency topology, typically 94% at 5.0Vdc
- Industry standard footprint
- Wide ambient temperature range,  $-40C$  to  $+85C$
- Cost efficient open frame design
- Programmable output voltage via external resistor from 0.7525 to 5.0Vdc
- No minimum load requirement (Stable at all loads)
- Remote ON/OFF
- Remote sense compensation
- Fixed switching frequency
- Continuous short-circuit protection and over current protection
- Over-temperature protection (OTP)
- Monotonic Startup with pre-bias at the output.
- UL/IEC/EN60950 Certified.
- Output Voltage Sequencing( Tracking )
- Power Good Signal (Option)

### 3. General Description

#### 3.1 Electrical Description

A block diagram of the SIP/SMT20W-12 Series converter is shown in Figure 1. Extremely high efficiency power conversion is achieved through the use of synchronous rectification and drive techniques. Essentially, the powerful SIP/SMT20W-12 series topology is based on a non-isolated synchronous buck converter. The control loop is optimized for unconditional stability, fast transient response and a very tight line and load regulation. In a typical pre-bias application the SIP/SMT20W-12 series converters do not draw any reverse current at start-up. The output voltage can be adjusted from 0.7525 to 5.0vdc, using the TRIM pin with a external resistor. The converter can be shut down via a remote ON/OFF input that is referenced to ground. This input is

compatible with popular logic devices; a 'positive' logic input is supplied as standard.

Positive logic implies that the converter is enabled if the remote ON/OFF input is high (or floating), and disabled if it is low. The converter is also protected against over-temperature conditions. If the converter is overloaded or the ambient temperature gets too high, the converter will shut down to protect the unit.

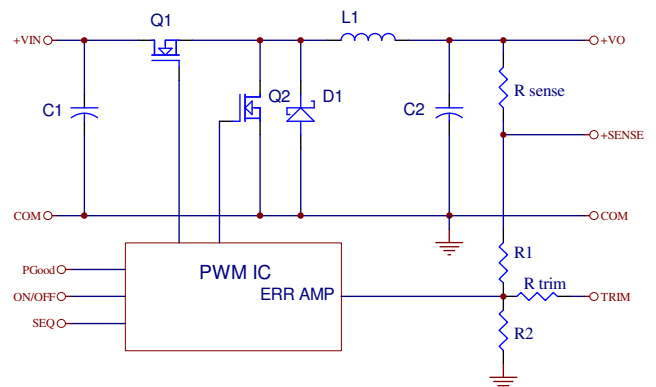

Figure 1. Electrical Block Diagram

#### 3.2 Thermal Packaging and Physical Design.

The SIP/SMT20W-12 series uses a multi-layer FR4 PCB construction. All surface mount power components are placed on one side of the PCB, and all low-power control components are placed on the other side. Thus, the Heat dissipation of the power components is optimized, ensuring that control components are not thermally stressed. The converter is an open-frame product and has no case or case pin. The open-frame design has several advantages over encapsulated closed devices. Among these advantages are:

- **Efficient Thermal Management:** the heat is removed from the heat generating components without heating more sensitive, small signal control components.
- **Environmental:** Lead free open-frame converters are more easily re-cycled.
- **Cost Efficient:** No encapsulation. Cost efficient open-frame construction.
- **Reliable:** Efficient cooling provided by open frame construction offers high reliability and easy diagnostics.



# SIP20W-12S05A, SMT20W-12S05A

## Application Note Ver10 Feb 2005

### 4. Technical Specifications

(All specifications are typical at nominal input, full load at 25°C unless otherwise noted.)

PARAMETER	NOTES and CONDITIONS	Device	Min.	Typical	Max.	Units
<b>ABSOLUTE MAXIMUM RATINGS</b>						
Input Voltage Continuous		ALL	0		16	Vdc
Operating Temperature See Thermal Considerations Section		ALL	-40		+85	°C
Storage Temperature		ALL	-55		+125	°C
<b>INPUT CHARACTERISTICS</b>						
Operating Input Voltage	$V_o \leq 4.5V$ $V_o \geq 5.0V$	ALL	6.0 6.5	12 12	14 14	Vdc
Input Under-Voltage Lockout						
Turn-On Voltage Threshold		ALL		5.0		Vdc
Turn-Off Voltage Threshold		ALL		4.0		Vdc
Lockout Hysteresis Voltage		ALL		1.0		Vdc
Maximum Input Current	$V_{in}=0$ to 14Vdc , $I_o=I_o,max.$	ALL			19	A
No-Load Input Current	$V_o=0.7525V$ $V_o=1.2V$ $V_o=1.5V$ $V_o=1.8V$ $V_o=2.0V$ $V_o=2.5V$ $V_o=3.3V$ $V_o=5.0V$	ALL		40 50 50 50 60 65 75 95		mA
Off Converter Input Current	Shutdown input idle current	ALL			10	mA
Inrush Current ( $I^2t$ )		ALL			0.4	A <sup>2</sup> s
Input Reflected-Ripple Current	P-P thru 1uH inductor, 5Hz to 20MHz	ALL		220		mA
<b>OUTPUT CHARACTERISTIC</b>						
Output Voltage Set Point	$V_{in}=\text{Nominal } V_{in}$ , $I_o=I_o,max.$ , $T_c=25^\circ C$	ALL	-1.5%	$V_o,set$	+1.5%	Vdc
Output Voltage Trim Adjustment Range	Selected by an external resistor	ALL	0.7525		5.0	Vdc
Output Voltage Regulation						
Load Regulation	$I_o=I_o.min$ to $I_o,max$	ALL	-0.5		+0.5	%
Line Regulation	$V_{in}=\text{low line to high line}$	ALL	-0.2		+0.2	%
Temperature Coefficient	$T_a=-40^\circ C$ to $85^\circ C$	ALL	-0.03		+0.03	%/°C
Output Voltage Ripple and Noise	5Hz to 20MHz bandwidth					
Peak-to-Peak	Full Load, 1uF ceramic and 10uF tantalum	ALL			75	mV
RMS	Full Load, 1uF ceramic and 10uF tantalum	ALL			30	mV
External Capacitive Load	Low ESR	ALL			8000	uF
Operating Output Current Range		ALL	0		20	A
Output DC Current-Limit Inception	Output Voltage =90% Nominal Output Voltage	ALL	24	30	36	A
Shout Circuit Protection	Continuous with Hiccup Mode					
Sequency Slew Rate Capability	$dV_{SEQ}/dt$		0.1		1.0	V/ms
Sequencing Delay Time			10			ms
Tracking Accuracy	Power up Power down	ALL			200 400	mV
Power Good Signal	Asserted Logic High $V_o$	Suffix "P"	90		110	%



# SIP20W-12S05A, SMT20W-12S05A

## Application Note Ver10 Feb 2005

PARAMETER	NOTES and CONDITIONS	Device	Min.	Typical	Max.	Units
<b>DYNAMIC CHARACTERISTICS</b>						
Output Voltage Transient Response						
Error Band	50% Step Load Change, di/dt=2.5A/us	ALL			200	mV
Setting Time (within 1% Vout nominal)	50% Step Load Change, di/dt=2.5A/us	ALL			200	us
<b>EFFICIENCY</b>						
100% Load	Vo=0.7525V Vo=1.2V Vo=1.5V Vo=1.8V Vo=2.0V Vo=2.5V Vo=3.3V Vo=5.0V	ALL		78 84 87 88 89 90 92 94		%
<b>ISOLATION CHARACTERISTICS</b>						
Input to Output	Non-isolation	ALL	0			Vdc
<b>FEATURE CHARACTERISTICS</b>						
Switching Frequency		ALL		300		KHz
ON/OFF Control, Positive Logic Remote On/Off Logic Low (Module Off) Logic High (Module On)	or Open Circuit	SIP16W-12S05A SIP16W-12S05AP SMT16W-12S05A SMT16W-12S05AP	0		0.4 Vin	Vdc Vdc
ON/OFF Control, Negative Logic Remote On/Off Logic Low (Module On) Logic High (Module Off)	or Open Circuit	SIP16W-12S05AN SIP16W-12S05ANP SMT16W-12S05AN SMT16W-12S05ANP	0 2.8		0.4 Vin	Vdc Vdc
ON/OFF Current (for both remote on/off logic)	Ion/off at Von/off=0.0V	ALL			1	mA
Leakage Current (for both remote on/off logic)	Logic High, Von/off=14V	ALL			1	mA
Turn-On Delay and Rise Time						
Turn-On Delay Time, From On/Off Control	Von/off to 10%Vo,set	ALL		3		ms
Turn-On Delay Time, From Input	Vin,min. to 10%Vo,set	ALL		3		ms
Output Voltage Rise Time	10%Vo,set to 90%Vo,set	ALL		4		ms
Over Temperature Protection		ALL		130		°C
<b>GENERAL SPECIFICATIONS</b>						
MTBF	Io=100%of Io,max;Ta=25 °C per MIL-HDBK-217F	ALL		0.9		M hours
Weight		ALL		11		grams
Dimensions						
SIP packages	2.4x0.51x0.327 inches (61x12.95x8.3 mm)					
SMT packages	1.7x0.53x0.366 inches(43.2x13.46x9.3 mm)					



# SIP20W-12S05A, SMT20W-12S05A

## Application Note Ver10 Feb 2005

### 5. Main Features and Functions

#### 5.1 Operating Temperature Range

Cincon's SIP/SMT20W-12 series converters highly efficient converter design has resulted in its ability to operate over a wide ambient temperature environment (-40°C to 85°C). Due consideration must be given to the de-rating curves when ascertaining maximum power that can be drawn from the converter. The maximum power drawn is influenced by a number of factors, such as:

- Input voltage range.
  - Output load current.
  - Air velocity (forced or natural convection).
  - Mounting orientation of converter PCB with respect to the Airflow.
  - Motherboard PCB design, especially ground and power planes.
- These can be effective heat sinks for the converter.

#### 5.2 Over-Temperature Protection (OTP)

The SIP/SMT16W-12 Series converters are equipped with non-latching over-temperature protection. A temperature sensor monitors the temperature of the hot spot (typically, top switch). If the temperature exceeds a threshold of 130°C (typical) the converter will shut down, disabling the output. When the temperature has decreased the converter will automatically restart.

The over-temperature condition can be induced by a variety of reasons such as external overload condition or a system fan failure.

#### 5.3 Output Voltage Adjustment

Section 7.8 describes in detail as to how to trim the output voltage with respect to its set point. The output voltage on all models is trimmable in the range 0.7525 – 5.0Vdc.

#### 5.4 Safe Operating Area (SOA)

Figure 2 provides a graphical representation of the Safe Operating Area (SOA) of the converter. This representation assumes ambient operating conditions such as airflow are met as per thermal guidelines provided in Sections 7.2 and 7.3.

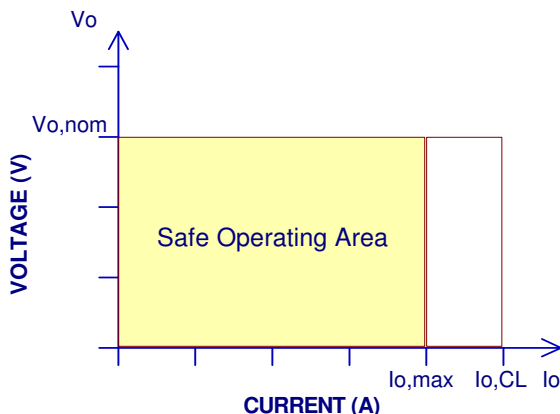

Figure 2. Maximum Output Current Safe Operating Area

#### 5.5 Over Current Protection

All different voltage models have a full continuous short-circuit protection. The unit will auto recover once the short circuit is removed. To provide protection in a fault condition, the unit is equipped with internal over-current protection. The unit operates normally once the fault condition is removed. The power module will supply up to 150% of rated current. In the event of an over current converter will go into a hiccup mode protection.

#### 5.6 Remote ON/OFF

The remote ON/OFF input feature of the converter allows external circuitry to turn the converter ON or OFF. Active-high remote ON/OFF is available as standard. The SIP/SMT20W-12S05A are turned on if the remote ON/OFF pin is high(=Vin), or left open. Setting the pin low(<0.4Vdc) will turn the converter 'OFF'. The signal level of the remote on/off input is defined with respect to ground. If not using the remote on/off pin, leave the pin open (module will be on). The part number suffix "N" is Negative remote ON/OFF version. The unit is guaranteed OFF over the full temperature range if this voltage level exceeds 2.8Vdc. The converters are turned on If the on/off pin input is low (<0.4Vdc) or left open. The recommended SIP/SMT remote on/off drive circuit as shown as figure 3, 4.

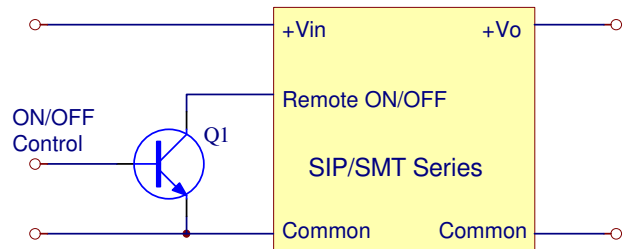

Figure 3. Positive Remote ON/OFF Input Drive Circuit

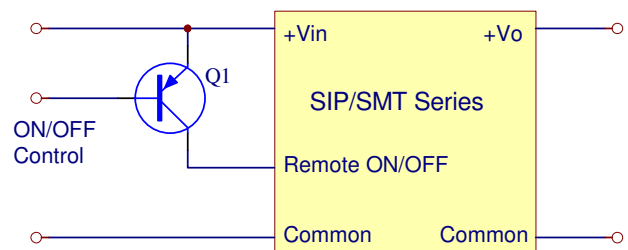

Figure 4. Negative Remote ON/OFF Input Drive Circuit



# SIP20W-12S05A, SMT20W-12S05A

## Application Note Ver10 Feb 2005

### 5.7 UVLO (Under-Voltage Lockout)

The voltage on the Vcc pin determines the start of the operation of the Converter. When the input Vcc rises and exceeds about 5.0V the converter initiates a soft start. The UVLO function in the converter has a hysteresis (about 1V) built in to provide noise immunity at start-up.

### 5.8 Output Voltage Sequencing (Tracking)

The SIP/SMT20W series including a sequencing feature. It is able implement various types of output voltage sequencing in customer applications, SIP/SMT20W series is accomplishable through an additional sequencing pin. When not using the sequencing feature, tie the SEQ pin to +Vin. When the signal voltage is applied to the SEQ pin, the output voltage tracks this voltage until the output reaches the set point voltage. The SEQ voltage needs to be set higher than the set point of the module. The output voltage will be follow by the voltage on the SEQ pin. On the multiple modules application, we can connect SEQ pin and input signal voltage together to apply on the SEQ pin. Customers can get multiple modules to track their output voltages to follow the voltage of the SEQ pin.

To control this module for sequencing, when the input voltage applied to the module. The on/off pin is left unconnected so that the module is ON by default. After applying input voltage to the module, a minimum of 10msec delay is required before applying voltage on the SEQ pin and slew rate of the voltage on the SEQ pin see technical specifications "  $dV_{SEQ}/dt$  ". After 10msec delay, an Analog voltage is applied to the SEQ pin and the output voltage of the module will track this voltage until output voltage reaches the set point voltage. To initiate simultaneous shutdown of the modules, the SEQ pin voltage is lowered in a controlled manner. Output voltage of the modules track the voltages below their set-point voltage voltages. A valid input voltage must be maintained until the tracking and output voltages reach ground potential to ensure a controlled shutdown of the modules.

A typical example testing circuit used master DC/DC converter and SIP/SMT Module as shown as below:

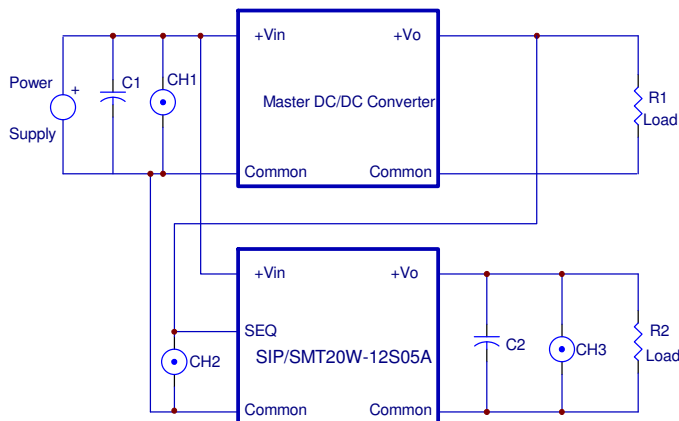

Figure 5. Example testing circuit of sequencing function

Power start up with SEQ signal  
 Input Voltage=12Vdc  
 Master DC/DC output voltage (CH1) = 5Vdc  
 Salve DC/DC output voltage (CH2)=3.3Vdc  
 Sequencing voltage= 0.67V/msec

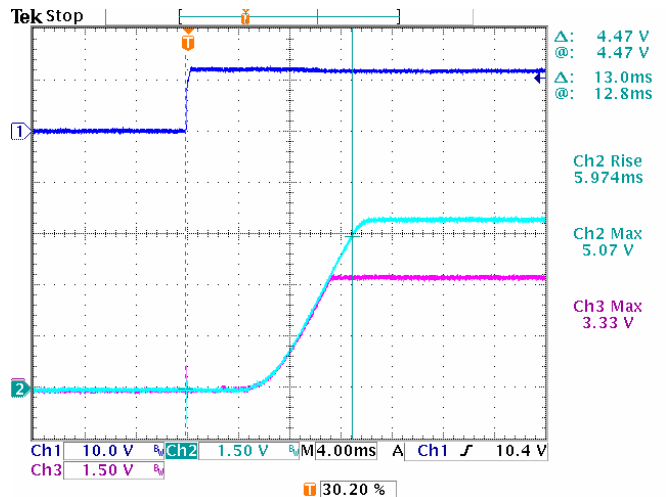

Figure 6. Example testing circuit of sequencing function

Power turn off with SEQ signal voltage  
 Input Voltage=12Vdc (CH1)  
 Master DC/DC output voltage (CH2) = 5Vdc  
 Salve DC/DC output voltage (CH3)=3.3Vdc

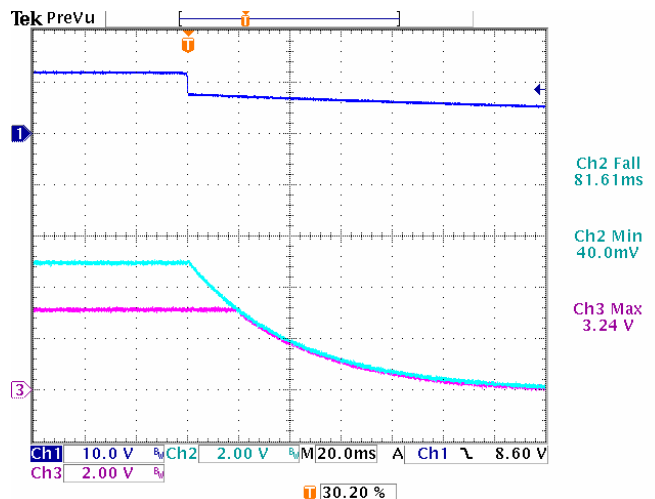

Figure 7. Example testing circuit of sequencing function



# SIP20W-12S05A, SMT20W-12S05A

## Application Note Ver10 Feb 2005

### 6. Safety

#### 6.1 Input Fusing and Safety Considerations.

**Agency Approvals:** The power Supply shall be submitted to and receive formal approval from the following test agencies.

1. The power supply shall be approved by a nationally recognized testing laboratory to UL/CSA 60950 3<sup>rd</sup> Edition (North America) and EN60950 (International)

2. CB Certificate from an internationally recognized test house in accordance with EN 60950.

The SIP/SMT20W-12 series converters do not have an internal fuse. However, to achieve maximum safety and system protection, always use an input line fuse. The safety agencies require a time-delay fuse with a maximum rating of 25A.

### 7. Applications

#### 7.1 Layout Design Challenges.

In optimizing thermal design the PCB is utilized as a heat sink. Also some heat is transferred from the SIP/SMT module to the main board through connecting pins. The system designer or the end user must ensure that other components and metal in the vicinity of the SIP/SMT20W-12 series meet the spacing requirements to which the system is approved.

Low resistance and low inductance PCB layout traces are the norm and should be used where possible. Due consideration must also be given to proper low impedance tracks between power module, input and output grounds. The recommended SIP/SMT footprint as shown as figure 8, 9.

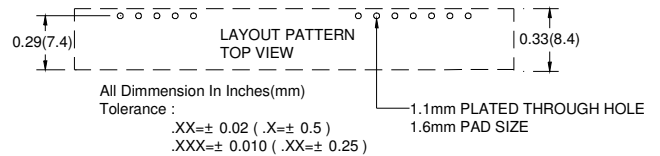
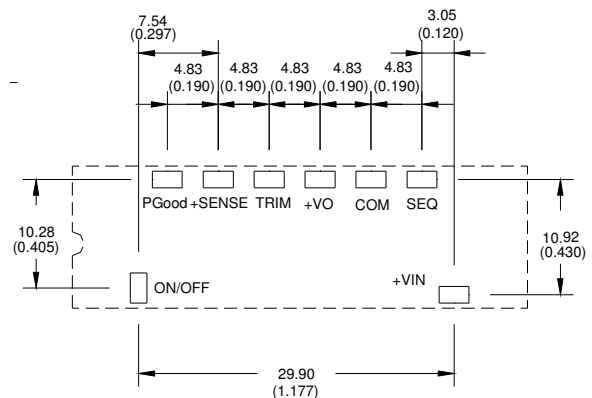

Figure 8. Recommended SIP Footprint

### Recommended Pad Layout

Dimensions are in millimetres and(inches)



#### PAD SIZE

MIN:3.556x2.413(0.140x0.095)

MAX:4.19x2.79(0.165x0.110)

Figure 9. Recommended SMT Footprint





# SIP20W-12S05A, SMT20W-12S05A

## Application Note Ver10 Feb 2005

### 7.2 Convection Requirements for Cooling

To predict the approximate cooling needed for the module, refer to the Power De-rating curves in Figures 13 to 14 . These de-rating curves are approximations of the ambient temperatures and airflows required to keep the power module temperature below its maximum rating. Once the module is assembled in the actual system, the module's temperature should be checked as shown in Figure 10 to ensure it does not exceed 120 °C.

Proper cooling can be verified by measuring the power module's temperature at " Tref " as shown in Figure 11,12.

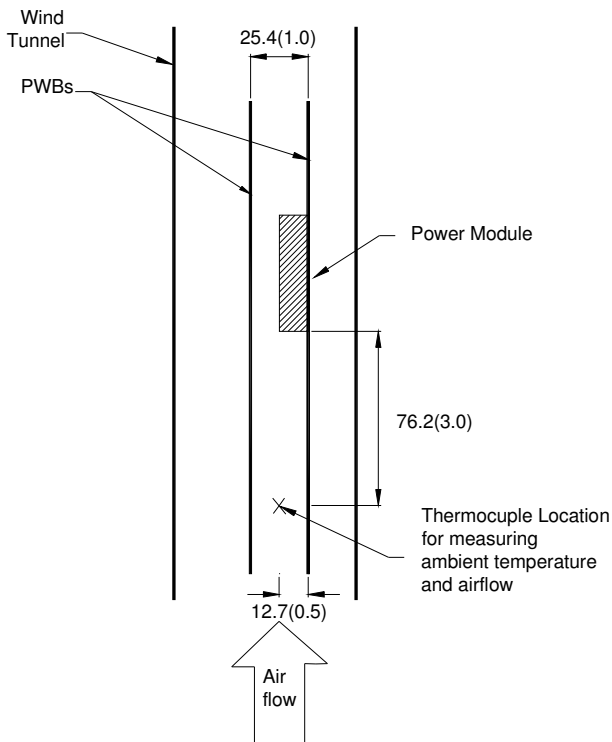

Note : Dimensions are in millimeters and (inches)

Figure 10. Thermal Test Setup

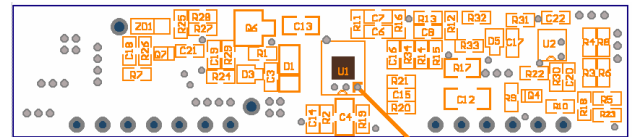

Figure 11. Temperature Measurement Location for SIP

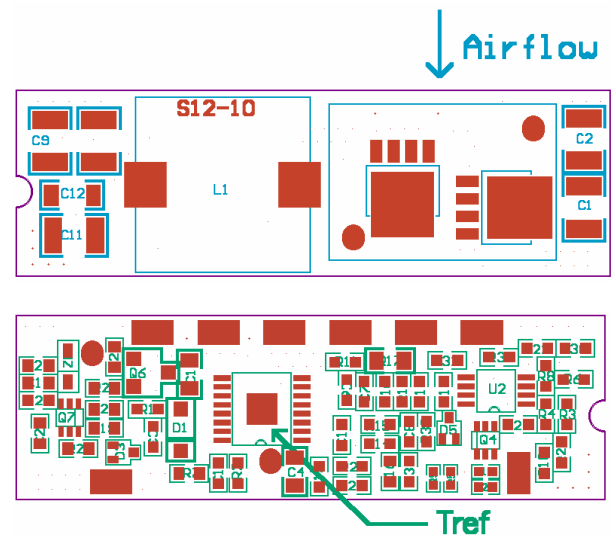
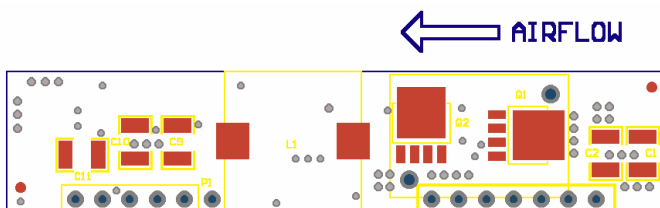

Figure 12. Temperature Measurement Location for SMT

### 7.3 Thermal Considerations

The power module operates in a variety of thermal environments; however, sufficient cooling should be provided to help ensure reliable operation of the unit. Heat is removed by conduction, convection, and radiation to the surrounding environment. The thermal data presented is based on measurements taken in a set-up as shown in Figure10. Figures 13 to 14 represent the test data. Note that the airflow is parallel to the long axis of the module as shown in Figure7 for the SIP/SMT. The temperature at " Tref " location should not exceed 120 °C. The output power of the module should not exceed the rated power for the module (VO, set x IO, max). The thermal data presented is based on measurements taken in a wind tunnel. The test setup shown in Figure 7 and EUT need to solder on 53.8mm x 43.2mm(2.12" x 1.7") test pcb. Note that airflow is parallel to the long axis of the module as shown in Fig10.





# SIP20W-12S05A, SMT20W-12S05A

## Application Note Ver10 Feb 2005

### 7.4 Power De-Rating Curves

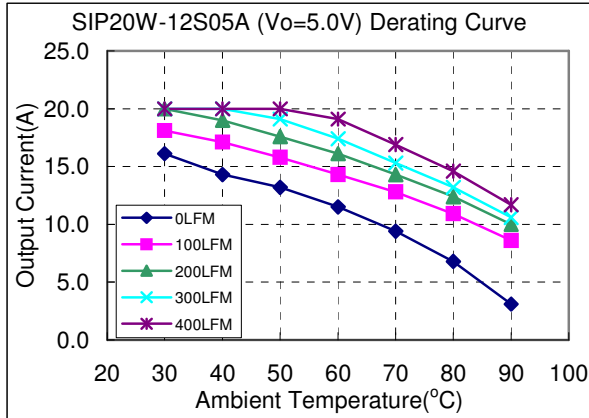

Figure13a. Typical Power De-rating for 12V IN 5.0Vout

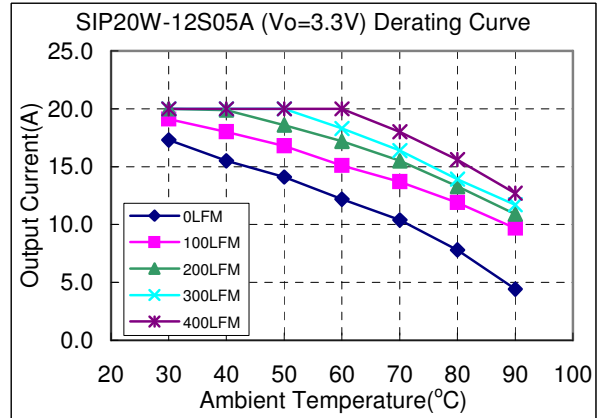

Figure 13b. Typical Power De-rating for 12V IN 3.3Vout

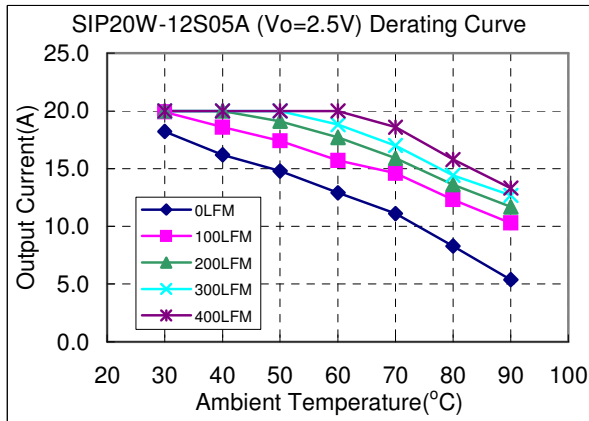

Figure13c. Typical Power De-rating for 12V IN 2.5Vout

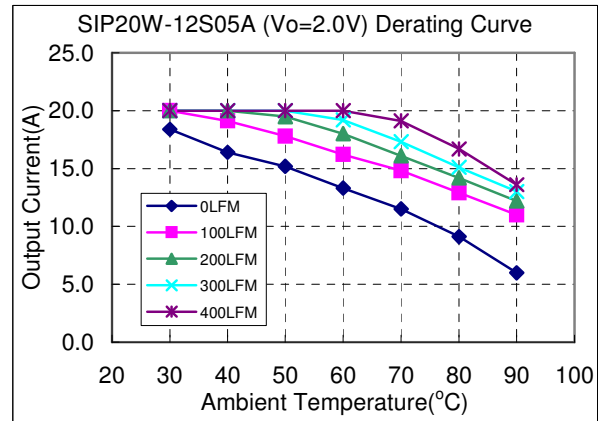

Figure 13d. Typical Power De-rating for 12V IN 2.0Vout

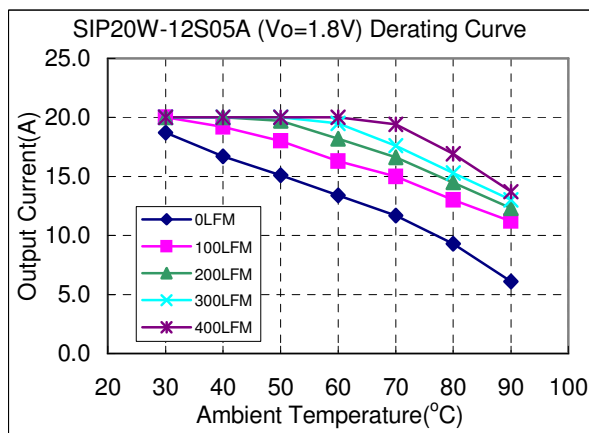

Figure13e. Typical Power De-rating for 12V IN 1.8Vout

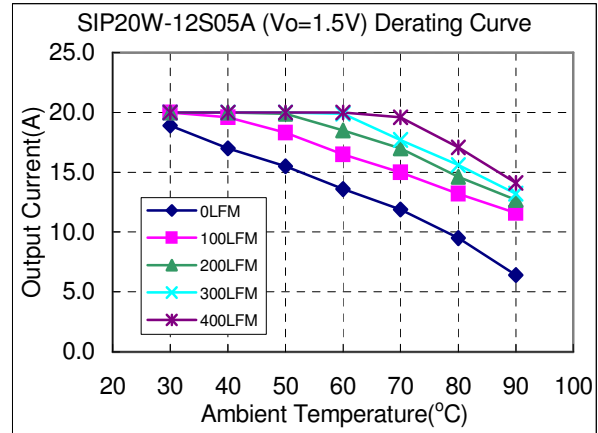

Figure 13f. Typical Power De-rating for 12V IN 1.5Vout



# SIP20W-12S05A, SMT20W-12S05A

## Application Note Ver10 Feb 2005

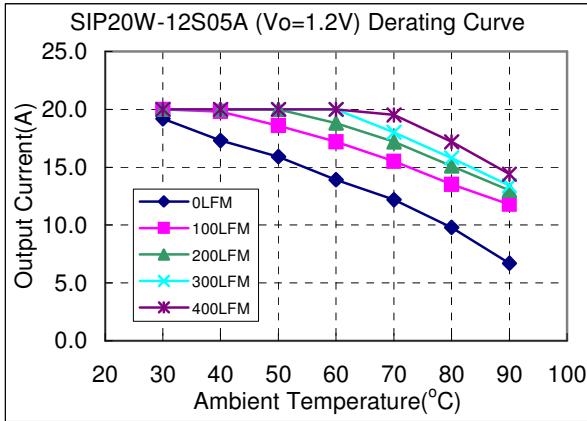

Figure13g. Typical Power De-rating for 12V IN 1.2Vout

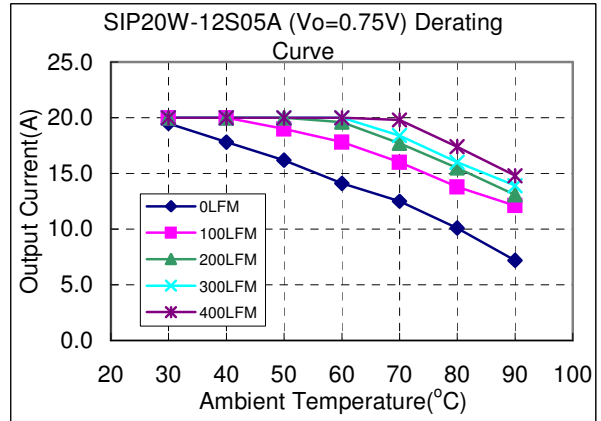

Figure 13h. Typical Power De-rating for 12V IN 0.75Vout

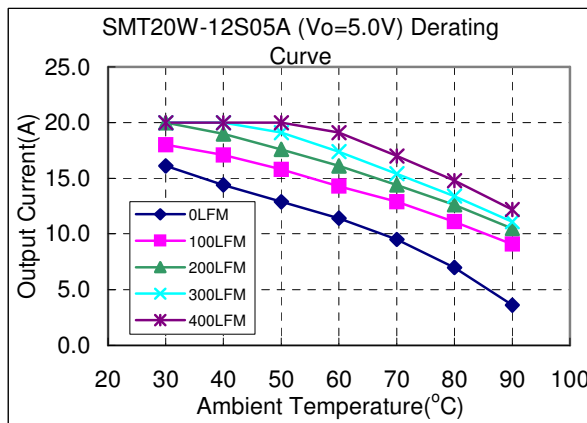

Figure14a. Typical Power De-rating for 12V IN 5.0Vout

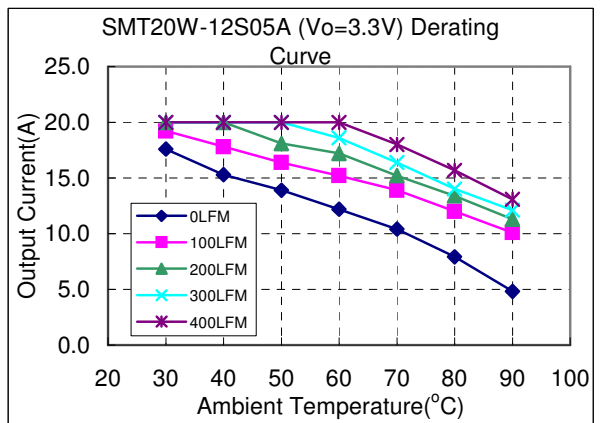

Figure 14b. Typical Power De-rating for 12V IN 3.3Vout

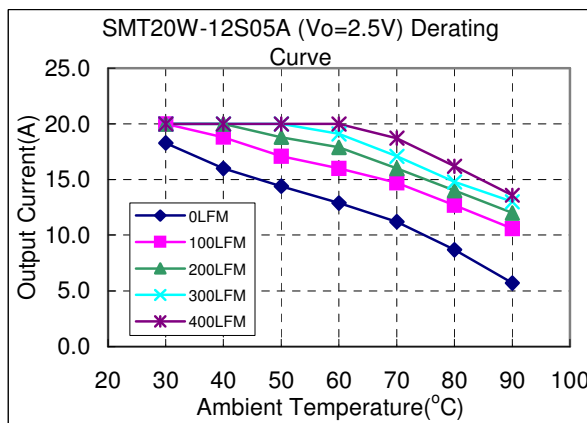

Figure14c. Typical Power De-rating for 12V IN 2.5Vout

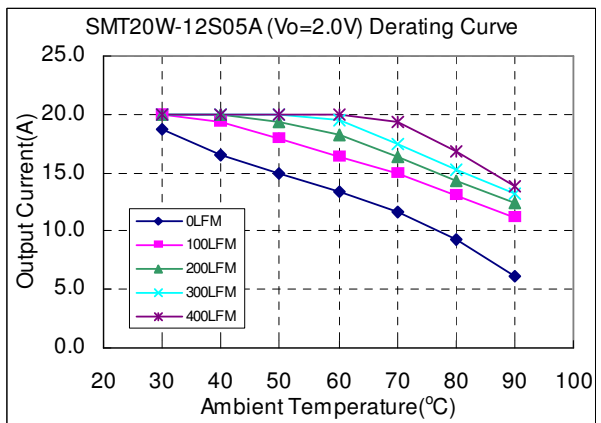

Figure 14d. Typical Power De-rating for 12V IN 2.0Vout



# SIP20W-12S05A, SMT20W-12S05A

## Application Note Ver10 Feb 2005

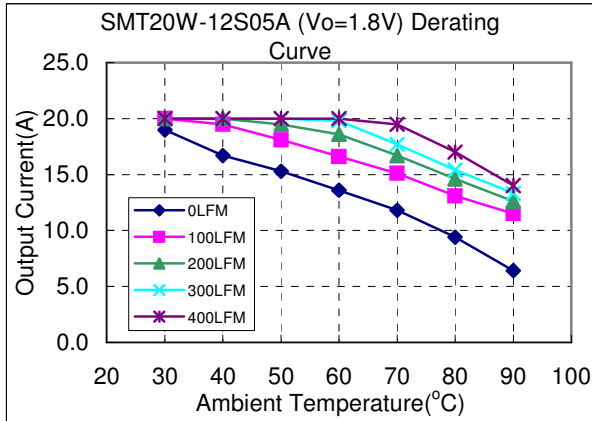

Figure 14e. Typical Power De-rating for 12V IN 1.8Vout

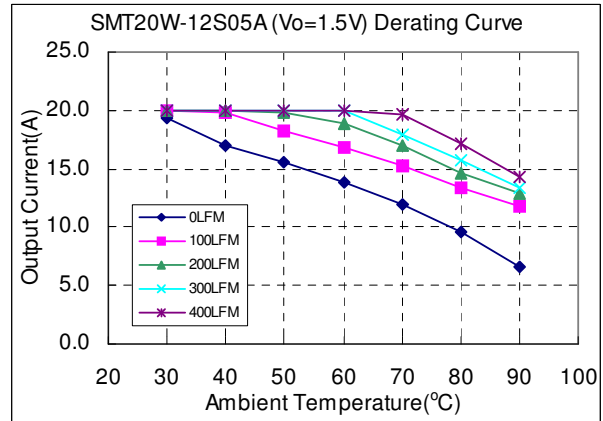

Figure 14d. Typical Power De-rating for 12V IN 1.5Vout

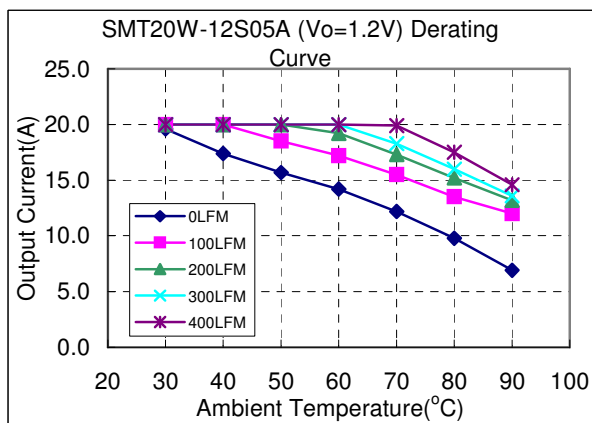

Figure 14f. Typical Power De-rating for 12V IN 1.2Vout

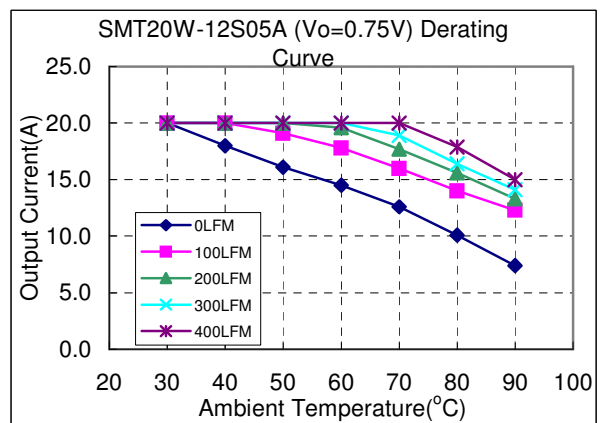

Figure 14g. Typical Power De-rating for 12V IN 0.75Vout



# SIP20W-12S05A, SMT20W-12S05A

## Application Note Ver10 Feb 2005

### 7.5 Efficiency vs Load Curves

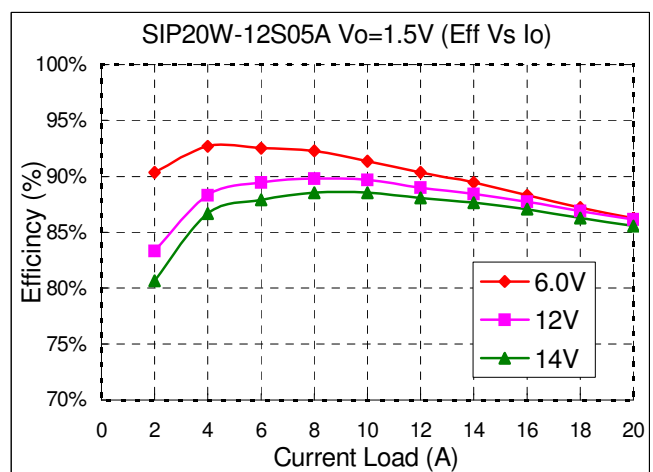
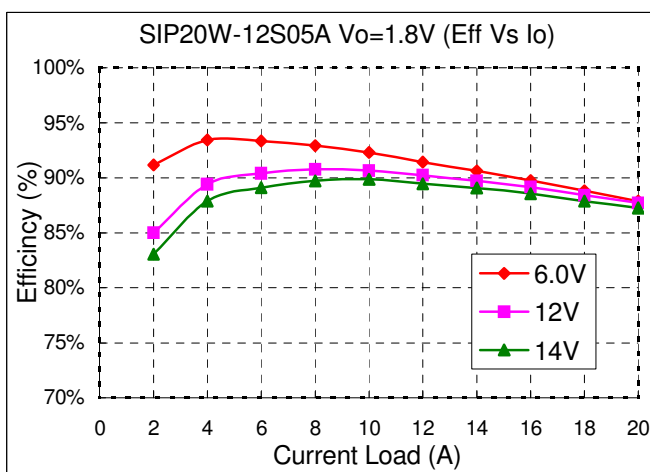
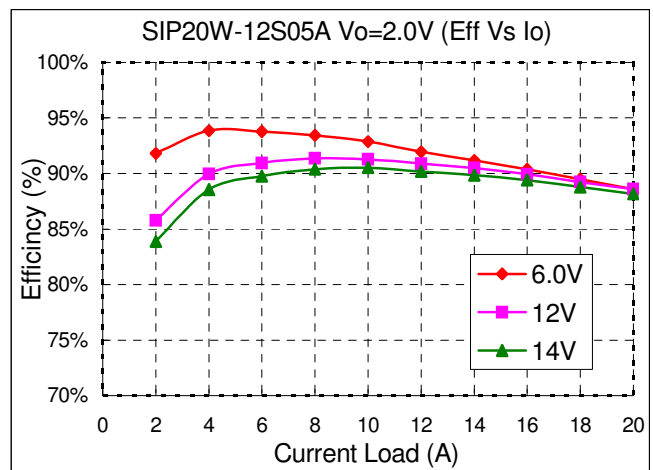
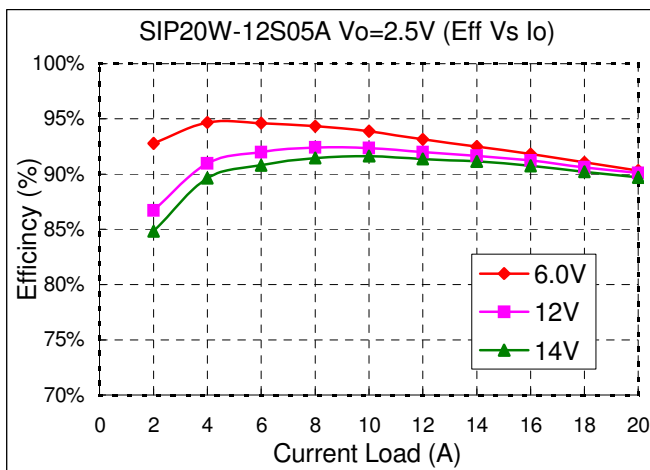
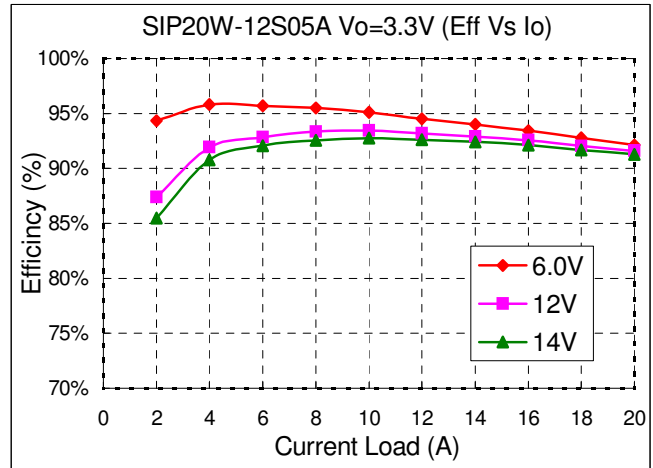
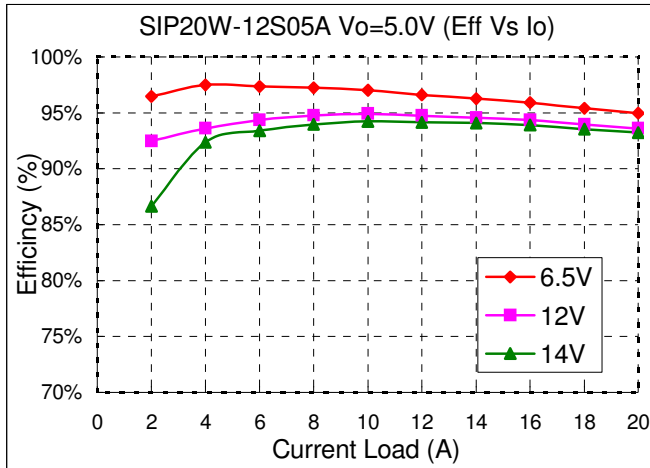



# SIP20W-12S05A, SMT20W-12S05A

## Application Note Ver10 Feb 2005

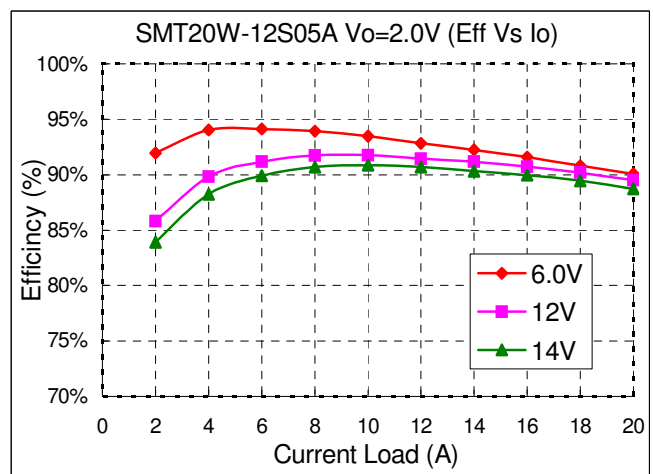
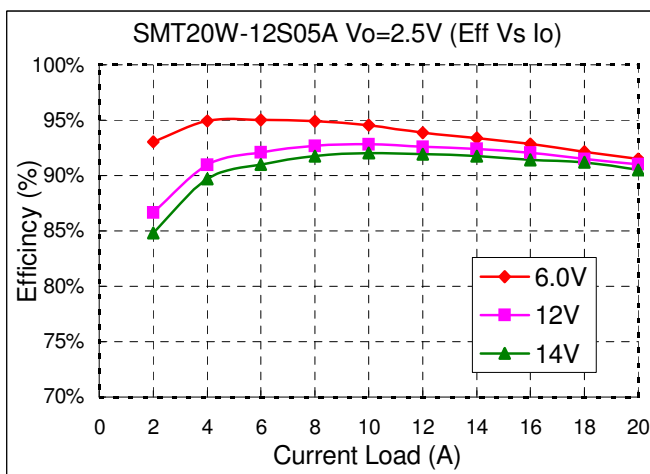
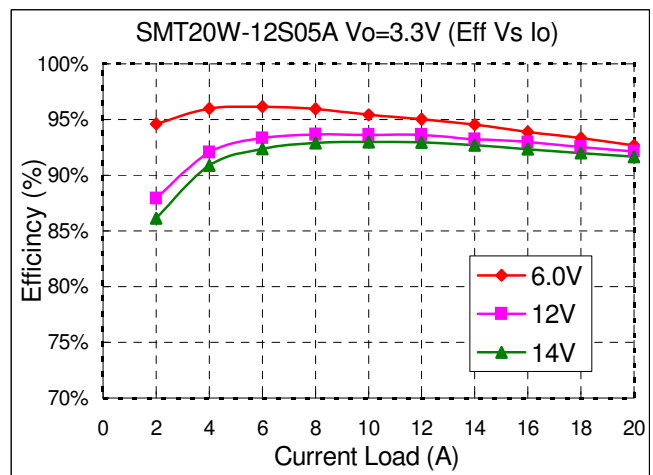
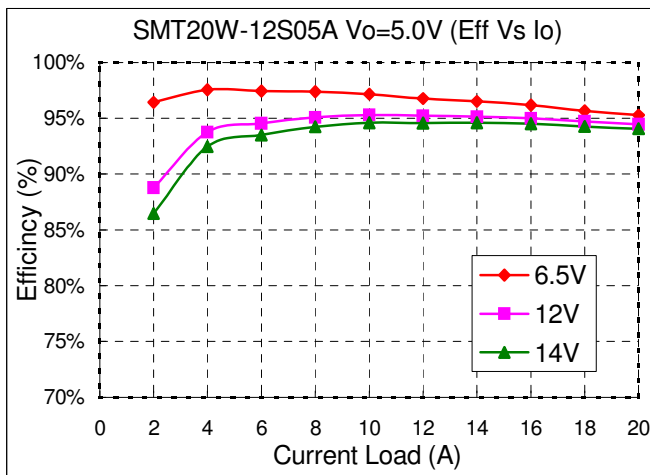
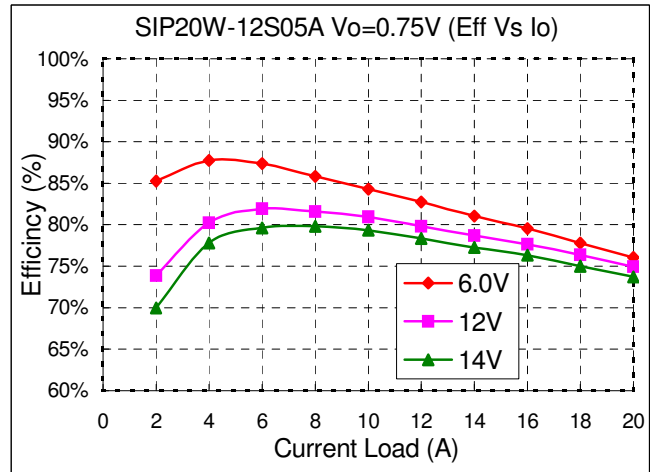
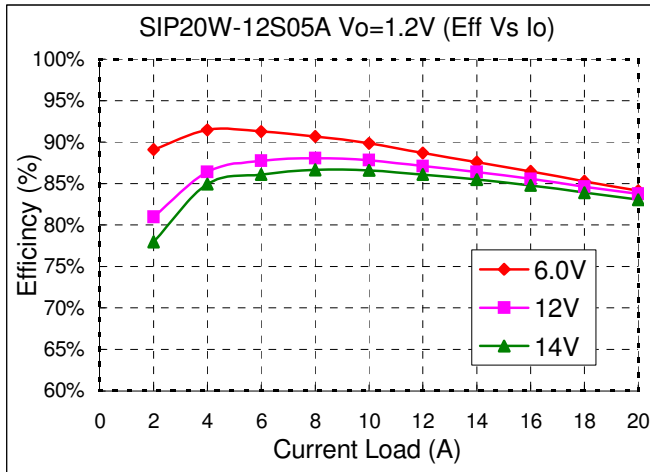



# SIP20W-12S05A, SMT20W-12S05A

## Application Note Ver10 Feb 2005

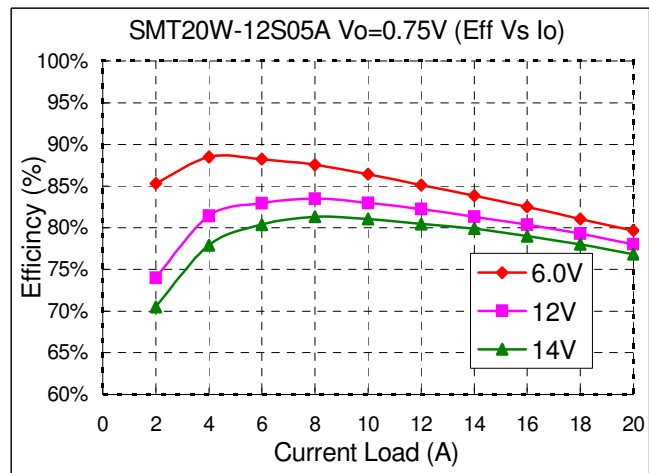
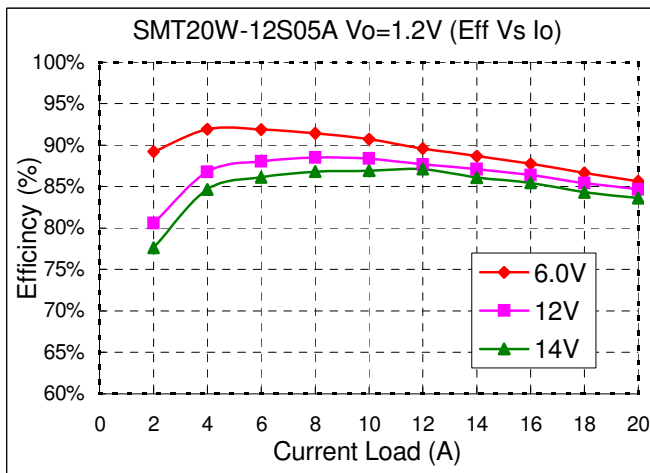
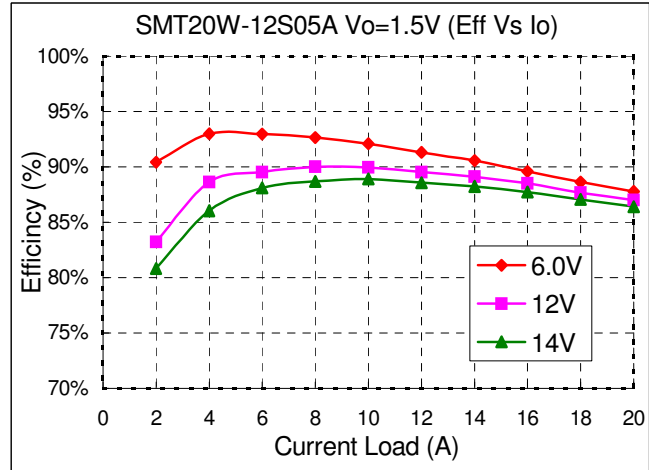
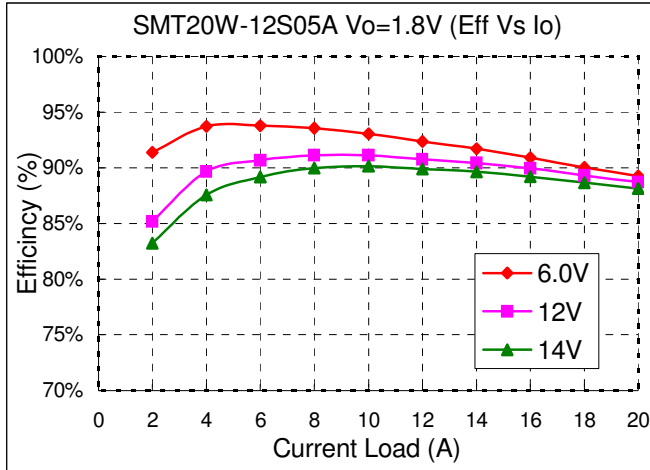



# SIP20W-12S05A, SMT20W-12S05A

## Application Note Ver10 Feb 2005

### 7.6 Input Capacitance at the Power Module

The SIP/SMT converters must be connected to a low AC source impedance. To avoid problems with loop stability source inductance should be low. Also, the input capacitors should be placed close to the converter input pins to de-couple distribution inductance. However, the external input capacitors are chosen for suitable ripple handling capability. Low ESR polymers are a good choice. They have high capacitance, high ripple rating and low ESR (typical <100mohm). Electrolytic capacitors should be avoided. Circuit as shown in Figure 15 represents typical measurement methods for ripple current. Input reflected-ripple current is measured with a simulated source Inductance of 1uH. Current is measured at the input of the module.

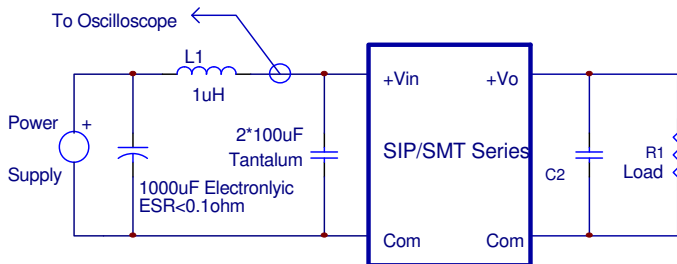

Figure 15. Input Reflected-Ripple Test Setup

### 7.7 Test Set-Up

The basic test set-up to measure parameters such as efficiency and load regulation is shown in Figure 16. Things to note are that this converter is non-isolated, as such the input and output share a common ground. These grounds should be connected together via low impedance ground plane in the application circuit. When testing a converter on a bench set-up, ensure that -Vin and -Vo are connected together via a low impedance short to ensure proper efficiency and load regulation measurements are being made. When testing the Cincon's SIP/SMT20W-12 series under any transient conditions please ensure that the transient response of the source is sufficient to power the equipment under test. We can calculate the

- Efficiency
- Load regulation and line regulation.

The value of efficiency is defined as:

$$\eta = \frac{V_o \times I_o}{V_{in} \times I_{in}} \times 100\%$$

Where:  $V_o$  is output voltage,  
 $I_o$  is output current,  
 $V_{in}$  is input voltage,  
 $I_{in}$  is input current.

The value of load regulation is defined as:

$$Load.reg = \frac{V_{FL} - V_{NL}}{V_{NL}} \times 100\%$$

Where:  $V_{FL}$  is the output voltage at full load  
 $V_{NL}$  is the output voltage at no load

The value of line regulation is defined as:

$$Line.reg = \frac{V_{HL} - V_{LL}}{V_{LL}} \times 100\%$$

Where:  $V_{HL}$  is the output voltage of maximum input voltage at full load.  
 $V_{LL}$  is the output voltage of minimum input voltage at full load.

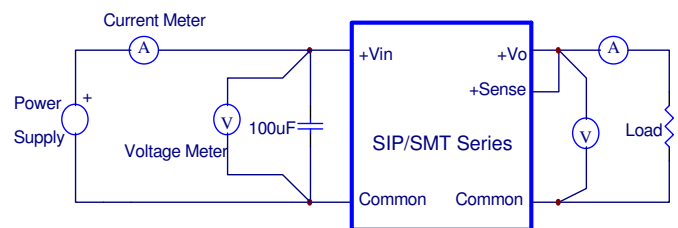

Figure 16. SIP/SMT20W Series Test Setup

### 7.8 Remote Sense Compensation

Remote Sense regulates the output voltage at the point of load. It minimizes the effects of distribution losses such as drops across the connecting pin and PCB tracks (see Figure 17). Please note however, the maximum drop from the output pin to the point of load should not exceed 500mV for remote compensation to work.

The amount of power delivered by the module is defined as the output voltage multiplied by the output current ( $V_o \times I_o$ ).

When using TRIM UP, the output voltage of the module will increase which, if the same output current is maintained, increases the power output by the module. Make sure that the maximum output power of the module remains at or below the maximum rated power.

When the Remote Sense feature is not being used, leave sense pin disconnected.

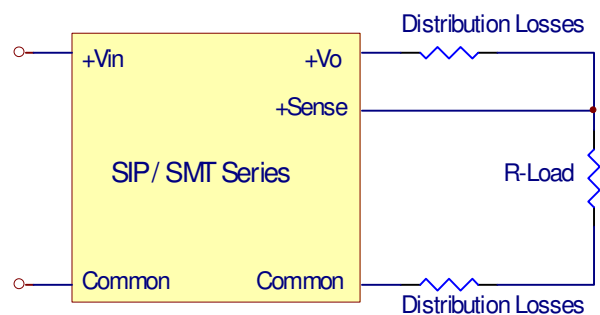

Figure 17. Circuit Configuration for Remote Sense Operation





# SIP20W-12S05A, SMT20W-12S05A

## Application Note Ver10 Feb 2005

### 7.9 SIP/SMT20W-12 Series Output Voltage Adjustment.

The output Voltage of the SIP/SMT20W-12S05A can be adjusted in the range 0.7525V to 5.0V by connecting a single resistor on the motherboard (shown as Rtrim) in Figure 18. When Trim resistor is not connected the output voltage defaults to 0.7525V

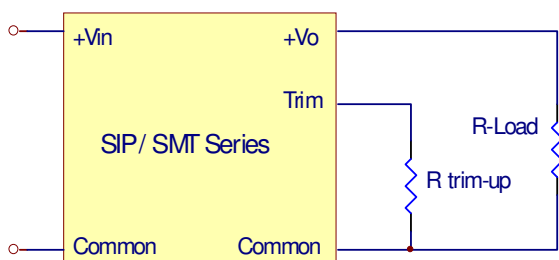

Figure 18. Trim-up Voltage Setup

The value of Rtrim-up defined as:

$$R_{trim} = \left( \frac{10500}{V_o - 0.7525} - 1000 \right)$$

Where:

Rtrim-up is the external resistor in ohm,

Vo is the desired output voltage

To give an example of the above calculation, to set a voltage of 3.3Vdc, Rtrim is given by:

$$R_{trim} = \left( \frac{10500}{3.3 - 0.7525} - 1000 \right)$$

Rtrim = 3.122K ohm

For various output values various resistors are calculated and provided in Table 3 for convenience.

Vo,set (V)	Rtrim (Kohm)
0.7525	Open
1.2	22.46
1.5	13.05
1.8	9.024
2.0	7.417
2.5	5.009
3.3	3.122
5.0	1.472

Table 3 – Trim Resistor Values

### 7.10 Output Ripple and Noise Measurement

The test set-up for noise and ripple measurements is shown in Figure 19. a coaxial cable with a 50ohm termination was used to prevent impedance mismatch reflections disturbing the noise readings at higher frequencies. The Output Ripple & Noise is measured with 1uf ceramic

and 10uf tantalum. The measured position are 50mm to 75mm(2" to 3") from the module. The "C1" is 200uF Tantalum capacitor ESR< 25mΩ

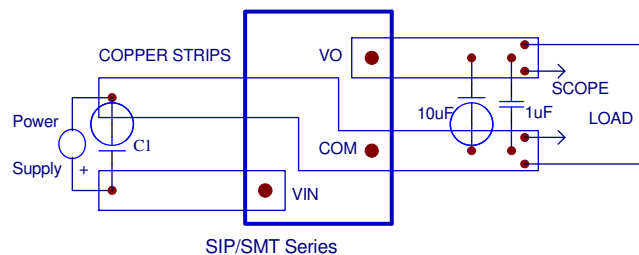

Figure 19. Output Voltage Ripple and Noise Measurement Set-Up

### 7.11 Output Capacitance

Cincon's SIP/SMT20W-12 series converters provide unconditional stability with or without external capacitors. For good transient response low ESR output capacitors should be located close to the point of load. For high current applications point has already been made in layout considerations for low resistance and low inductance tracks. Output capacitors with its associated ESR values have an impact on loop stability and bandwidth. Cincon's converters are designed to work with load capacitance up-to 8,000uF. It is recommended that any additional capacitance, typically 1,000uF and low ESR (<20mohm), be connected close to the point of load and outside the remote compensation point.

### 7.12 SMT Reflow Profile

An example of the SMT reflow profile is given in Figure 20.

**Equipment used:** SMD HOT AIR REFLOW HD-350SAR

**Alloy:** AMQ-M293TA or NC-SMQ92 IND-82088 SN63

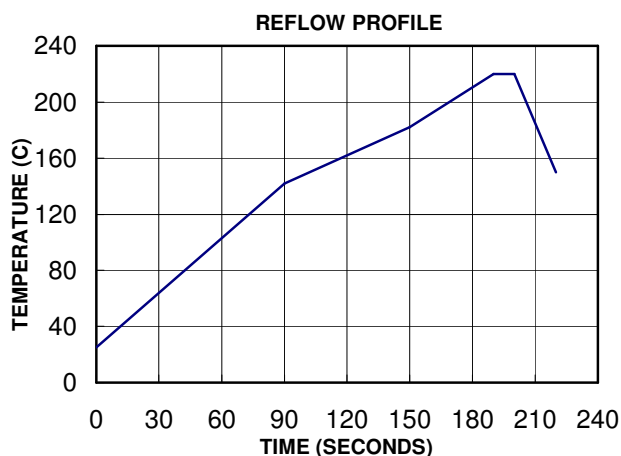

Figure 20 SMT Reflow Profile



# SIP20W-12S05A, SMT20W-12S05A

## Application Note Ver10 Feb 2005

### 8. Mechanical Outline Diagrams

#### 8.1 SIP/SMT20W Mechanical Outline Diagrams

Dimensions are in millimeters and inches

Tolerance: x.xx ±0.02 in. (0.5mm) , x.xxx ±0.010 in. (0.25 mm) unless otherwise noted

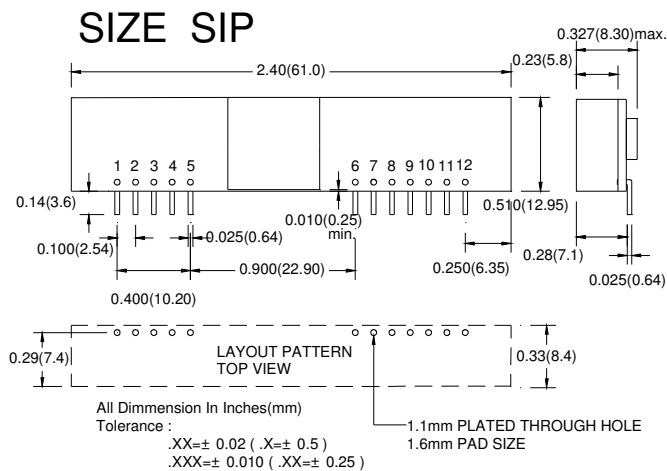

PIN CONNECTION	
Pin	FUNCTION
1	+Output
2	+Output
3	+Sense
4	+Output
5	Common
6	No Pin / PGood
7	Common
8	+V Input
9	+V Input
10	Sequency
11	Trim
12	On/Off Control

Figure 21 SIP20W-12 Mechanical Outline Diagram  
BOTTOM VIEW OF BOARD

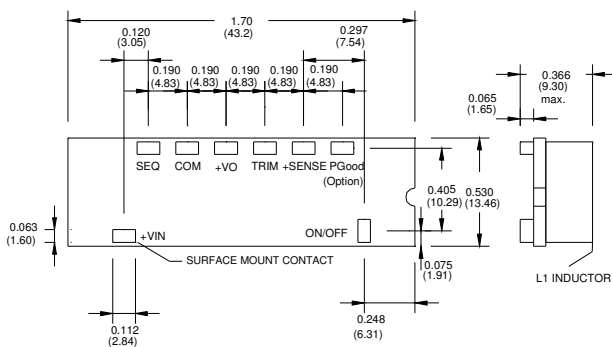
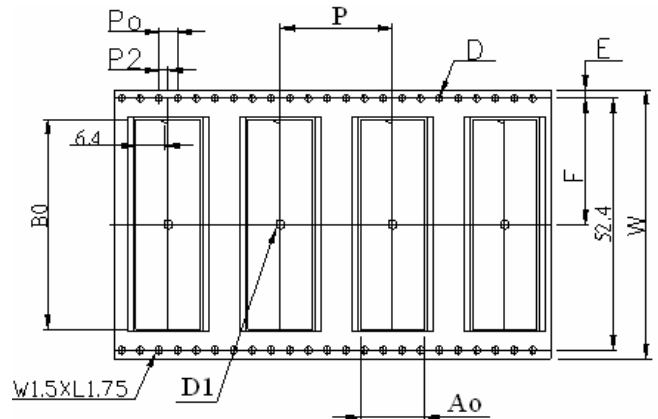

Figure 22 SMT20W-12 Mechanical Outline Diagram

#### 8.2 SMT Tape and Reel Dimensions

The Tape Reel dimensions for the SMT module is shown in Figure 23.



ITEM	SPEC
W	56.00 <sup>+0.30</sup> <sub>-0.30</sub>
Ao	13.80 <sup>+0.10</sup> <sub>-0.10</sub>
Bo	43.7 <sup>+0.10</sup> <sub>-0.10</sub>
Ko	9.50 <sup>+0.10</sup> <sub>-0.10</sub>
P	24.00 <sup>+0.10</sup> <sub>-0.10</sub>
F	26.20 <sup>+0.10</sup> <sub>-0.10</sub>
E	1.75 <sup>+0.10</sup> <sub>-0.10</sub>
D	1.50 <sup>+0.10</sup> <sub>-0.00</sub>
D1	2.00 <sup>+0.25</sup> <sub>-0.00</sub>
Po	4.00 <sup>+0.10</sup> <sub>-0.10</sub>
P2	2.00 <sup>+0.10</sup> <sub>-0.10</sub>
t	0.40 <sup>+0.05</sup> <sub>-0.05</sub>

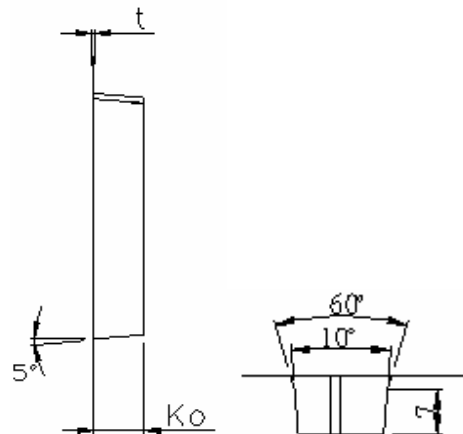

Figure 23 – SMT Tape and Reel Dimensions